

Todo sobre A a

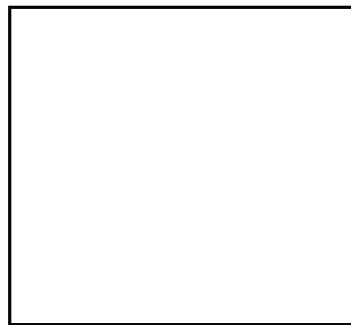

Recorta las imágenes. Pega las que comienzan con a

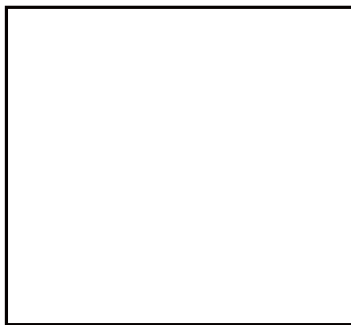
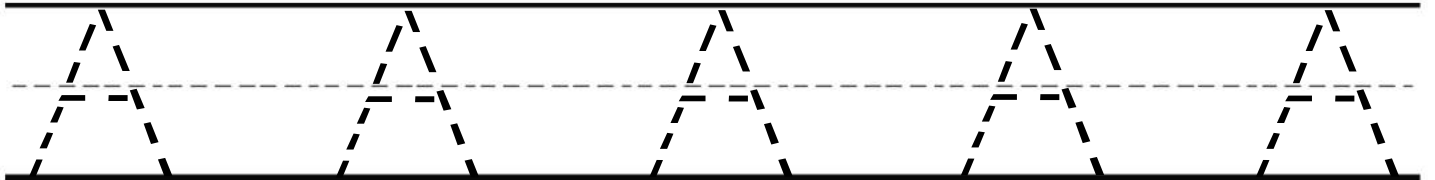
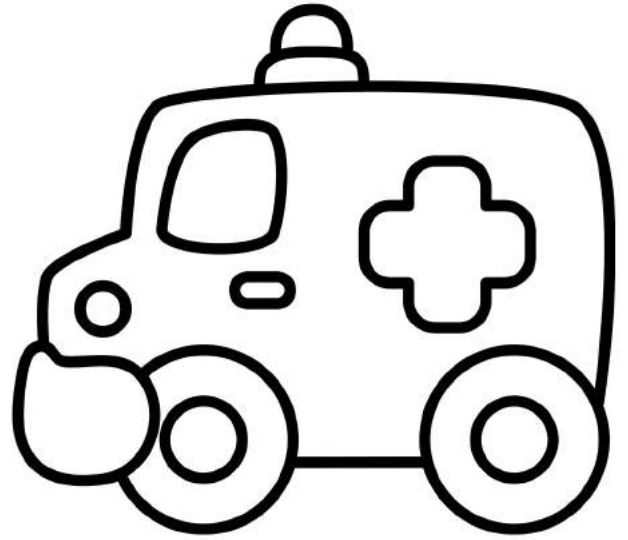
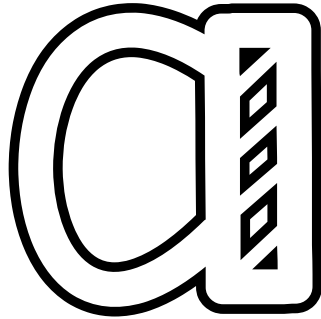
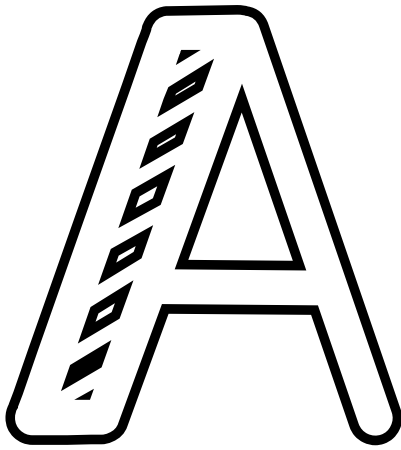
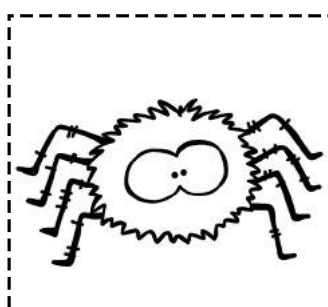
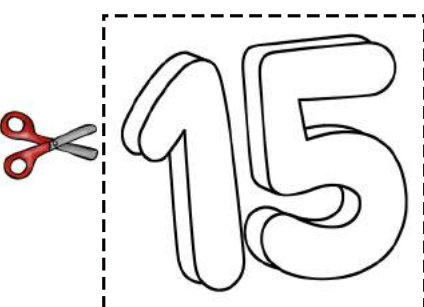

Todo sobre B b

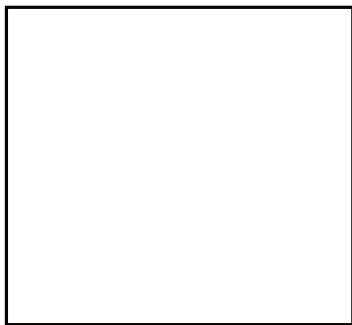
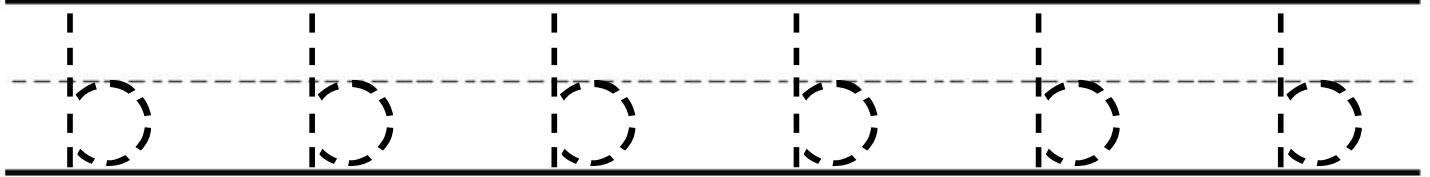
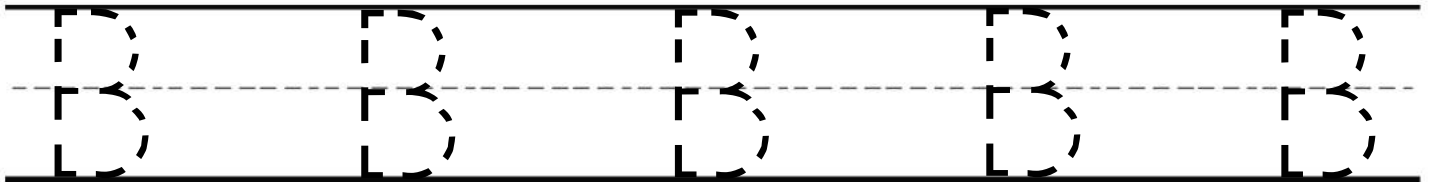
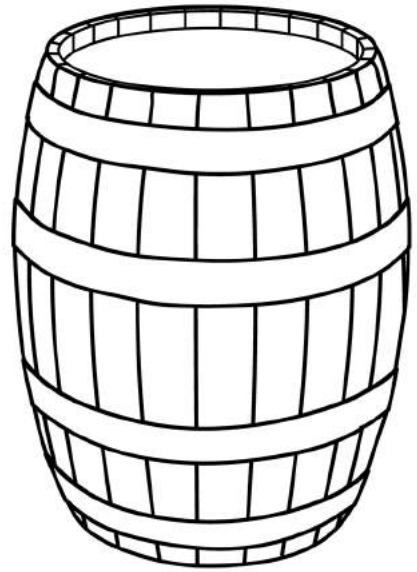
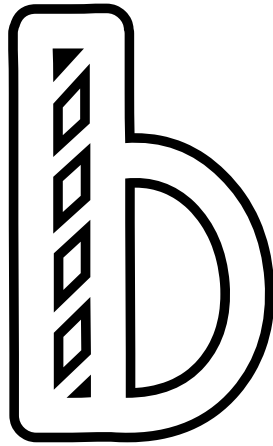
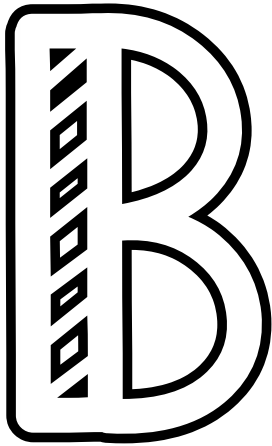

Recorta las imágenes. Pega las que comienzan con b

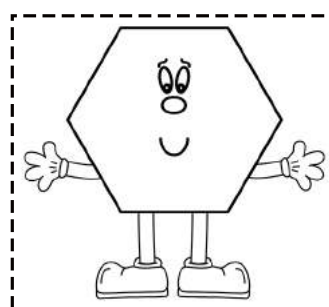
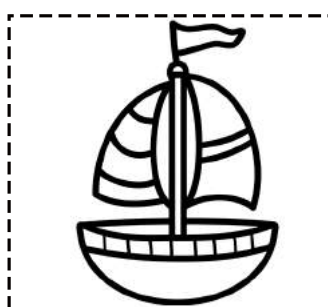
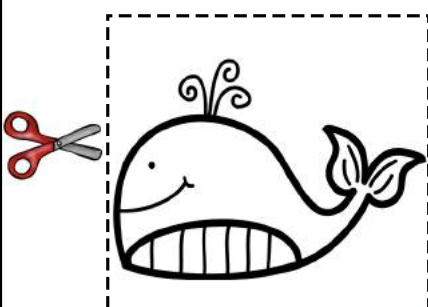

Todo sobre C c

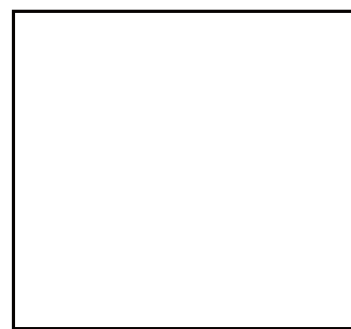
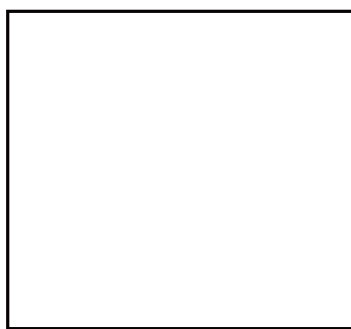
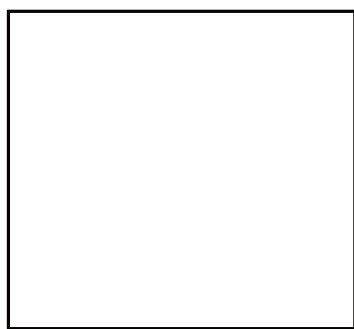
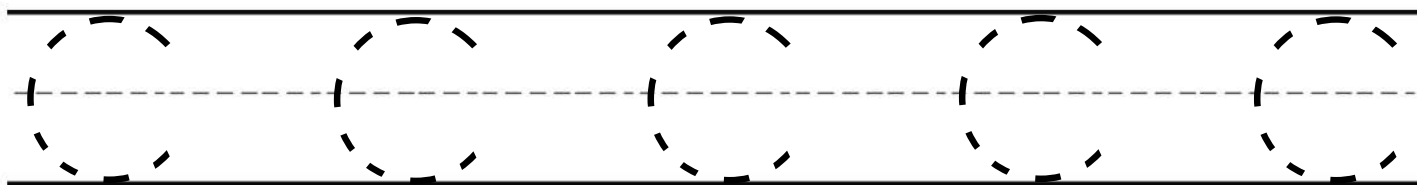
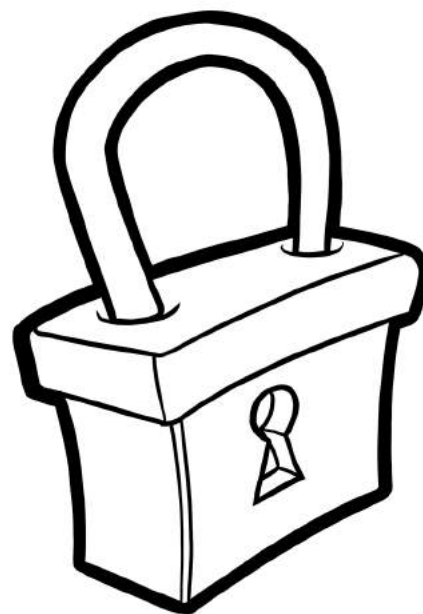
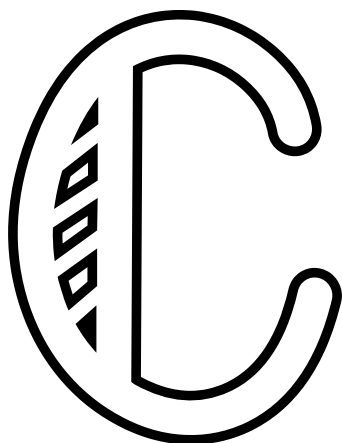

Recorta las imágenes. Pega las que comienzan con c

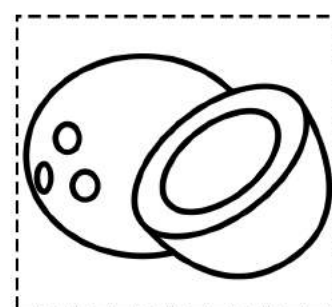
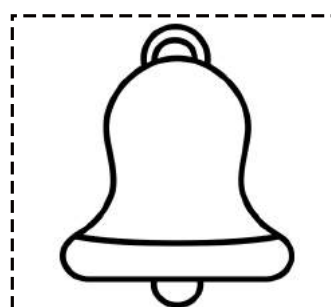
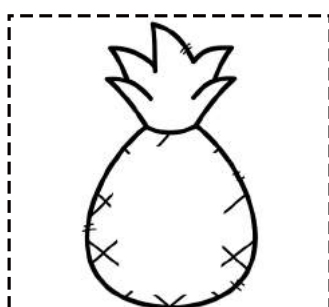
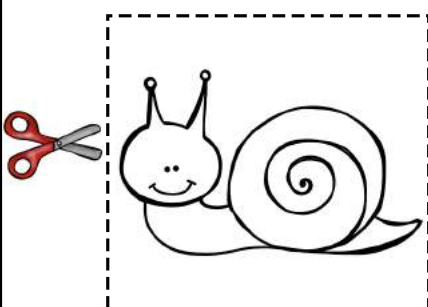

Todo sobre CH ch

CH ch



CH CH CH CH CH CH CH CH

ch ch ch ch ch ch ch ch

GLUE

Recorta las imágenes. Pega las que comienzan con ch

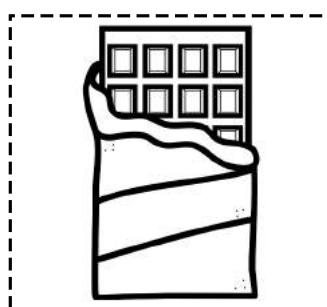
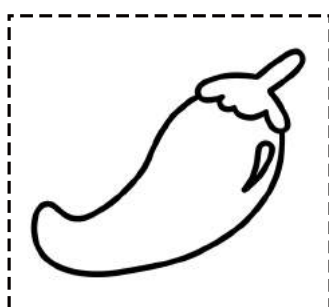
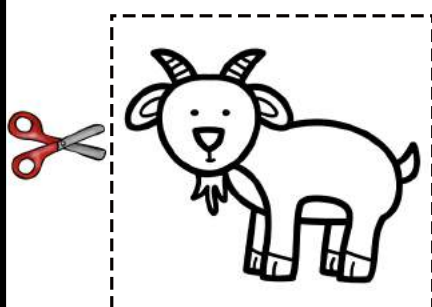

Todo sobre D d

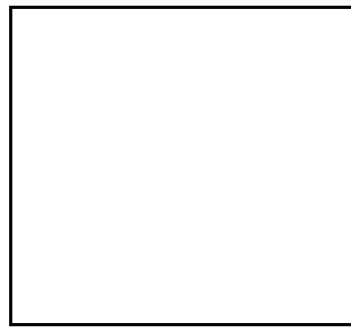
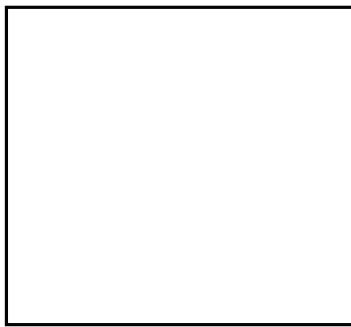
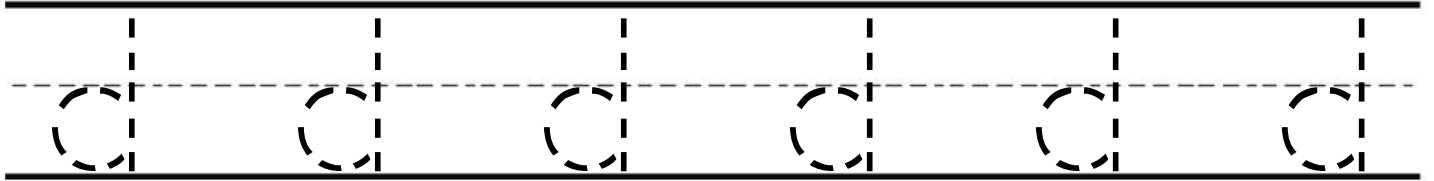
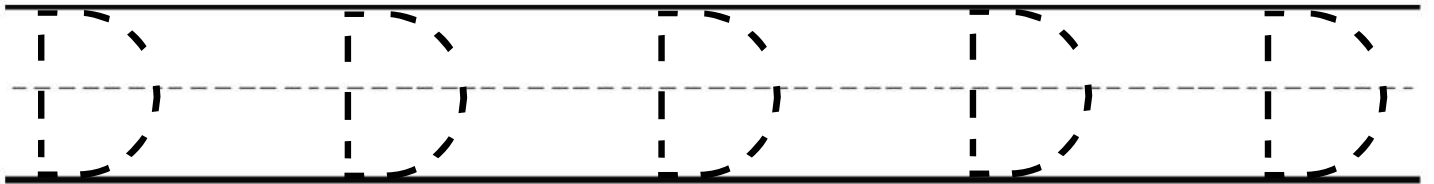
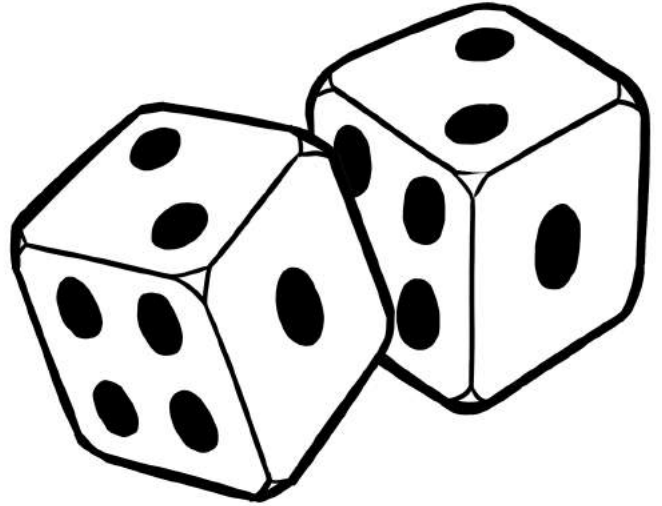
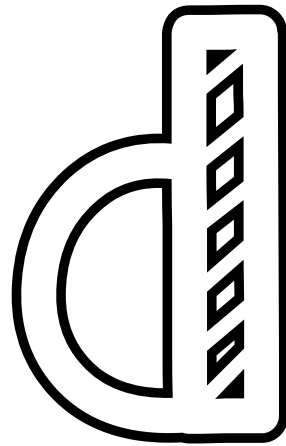
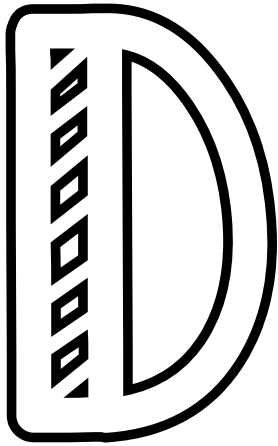

Recorta las imágenes. Pega las que comienzan con d

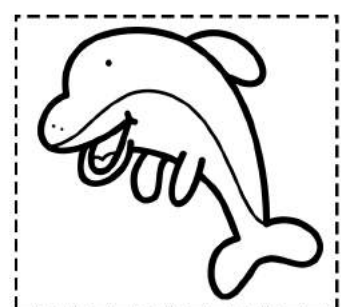
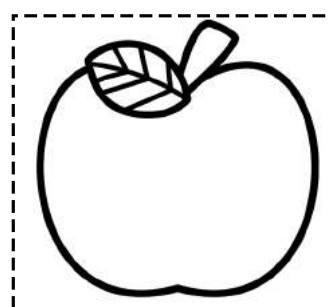
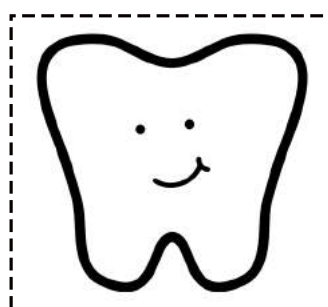
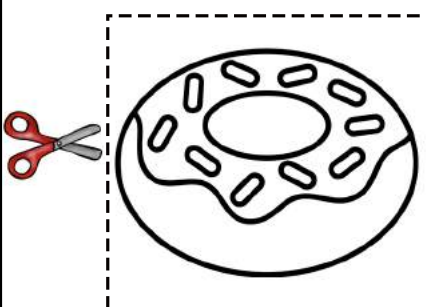

Todo sobre E e

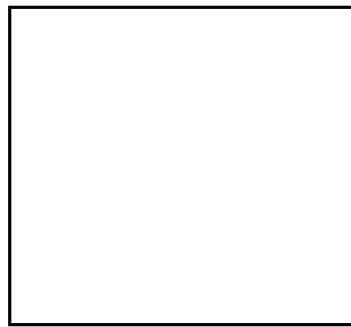
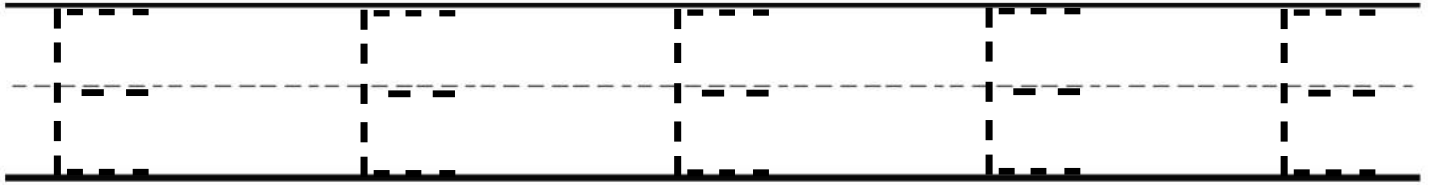
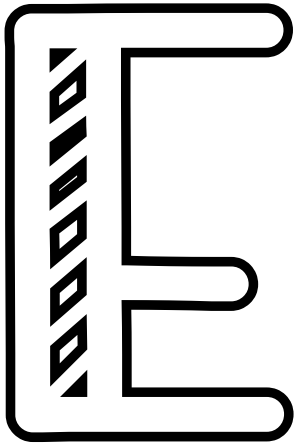

Recorta las imágenes. Pega las que comienzan con e

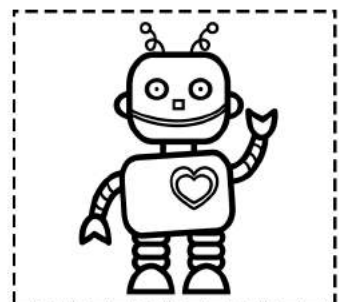
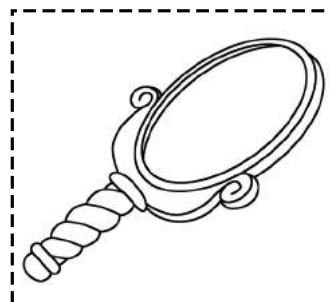
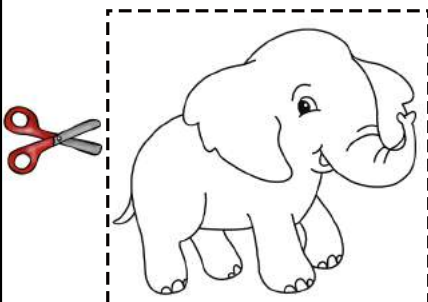

Todo sobre F f

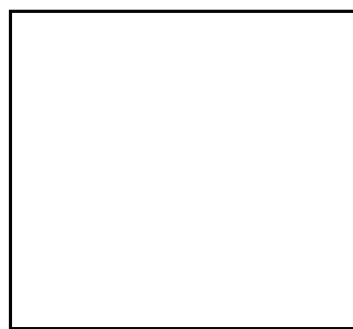
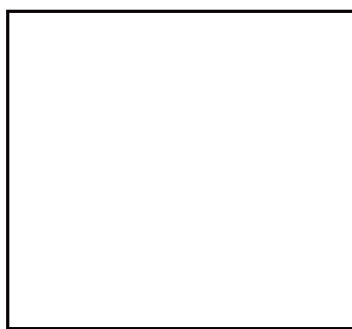
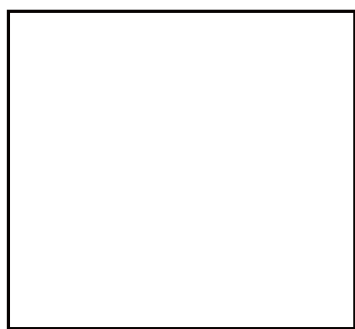
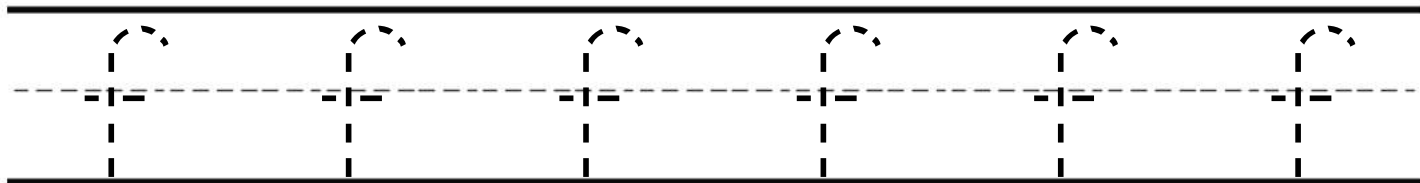
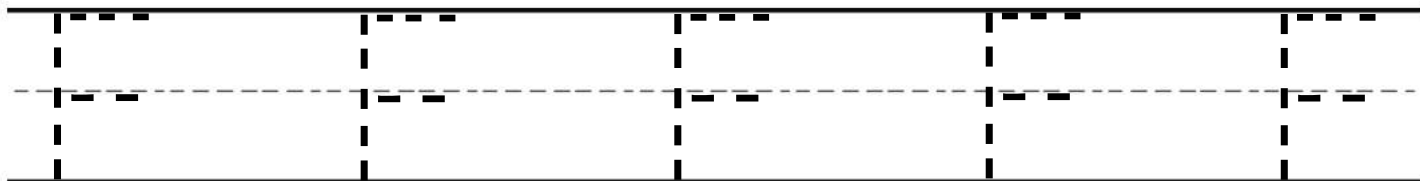
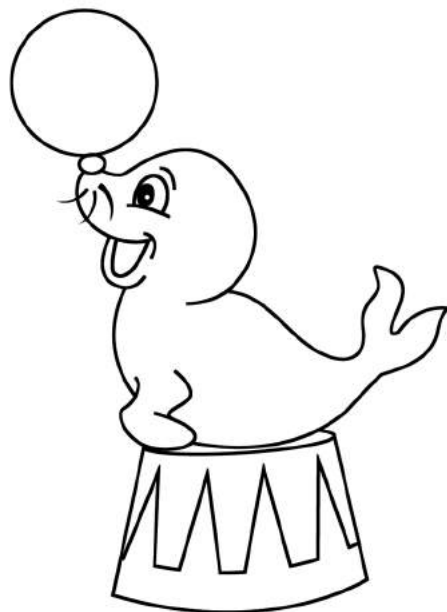
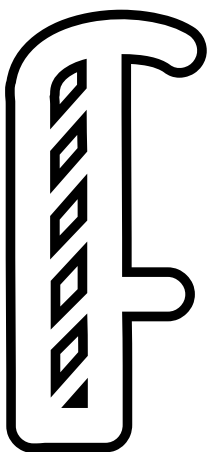
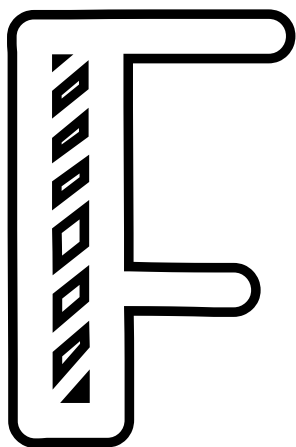

Recorta las imágenes. Pega las que comienzan con f

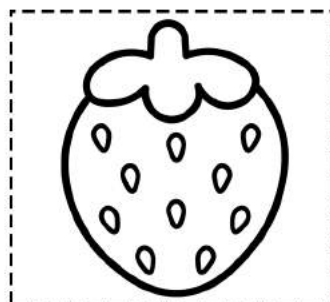
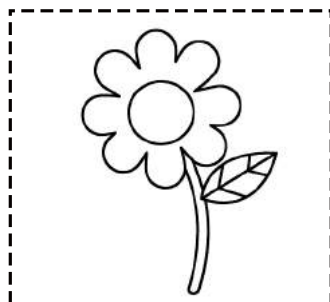
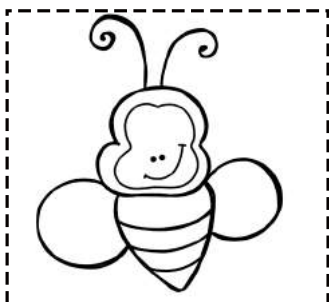
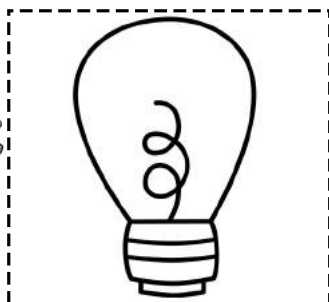

Todo sobre G g

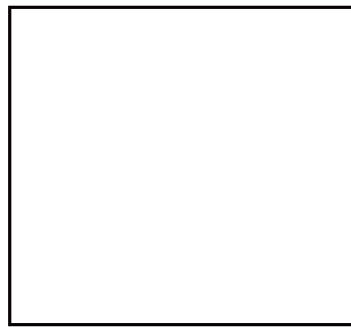
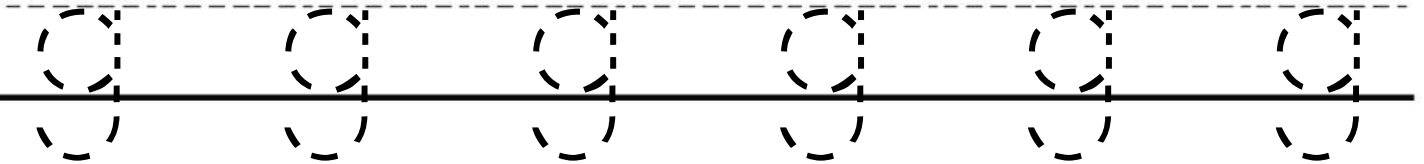
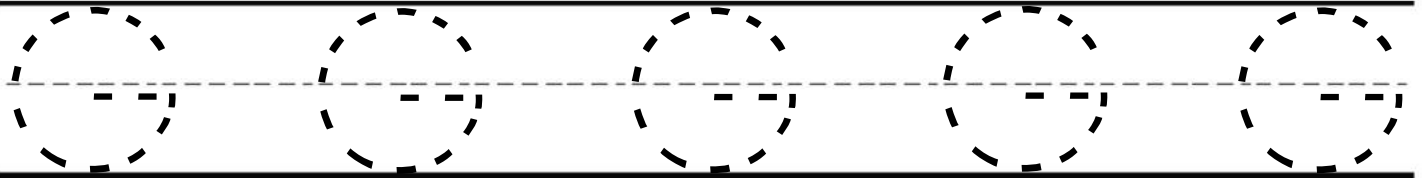
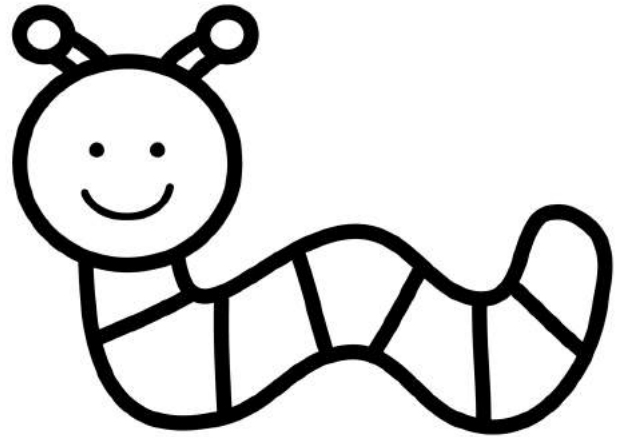
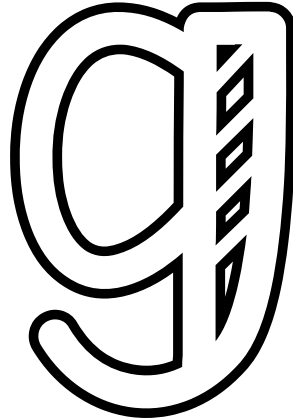

Recorta las imágenes. Pega las que comienzan con g

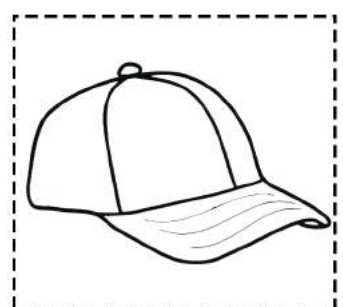
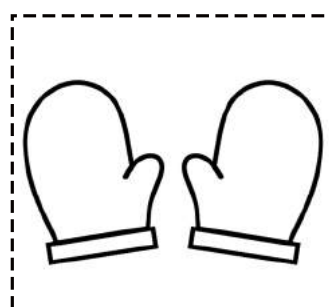
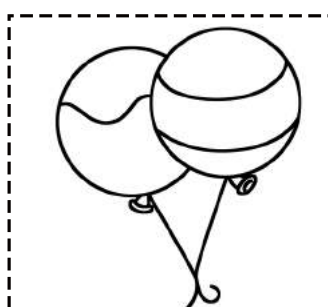
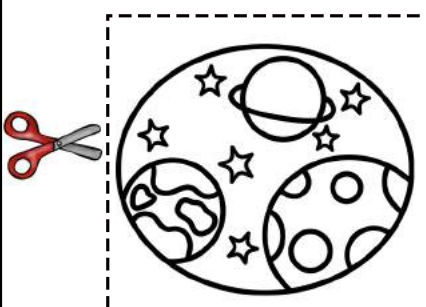

Todo sobre H h

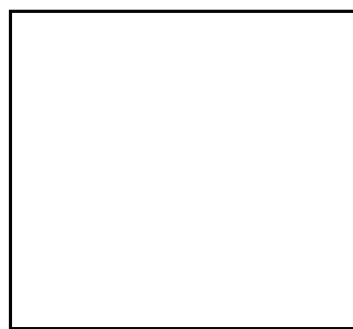
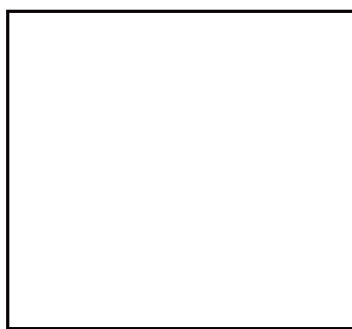
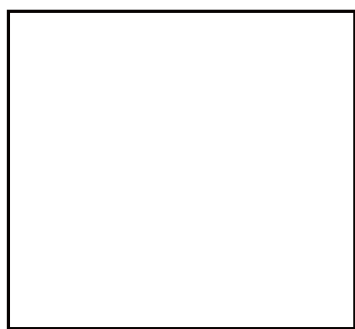
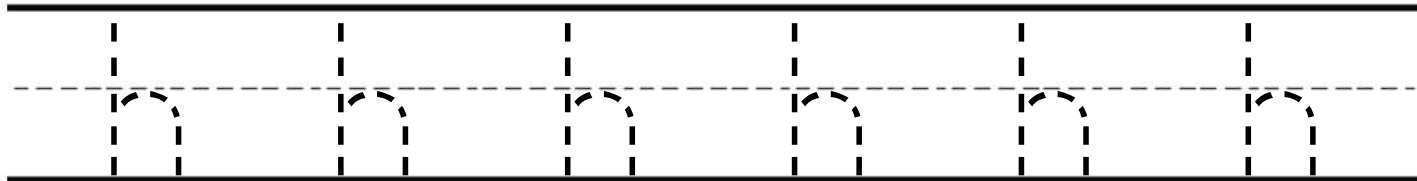
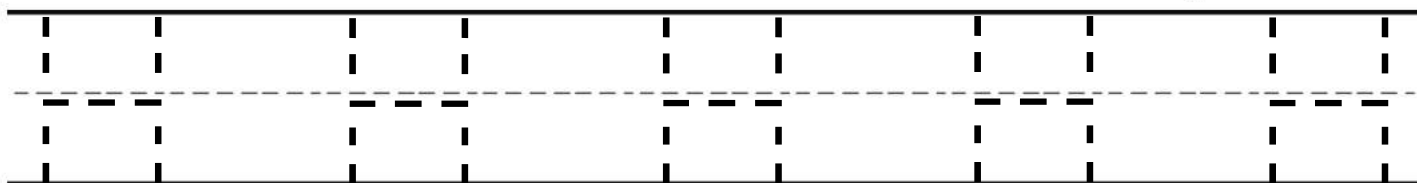
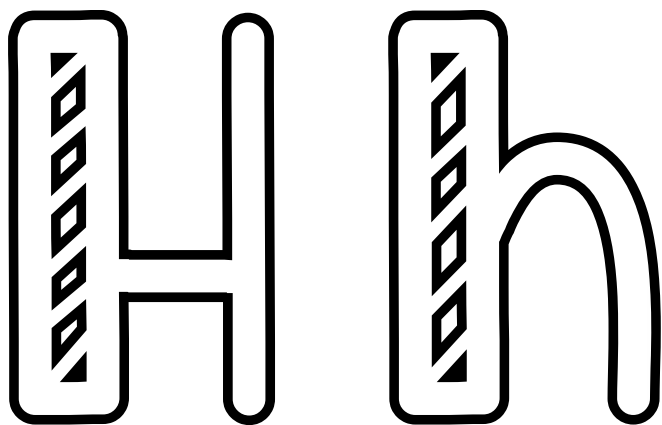

Recorta las imágenes. Pega las que comienzan con h

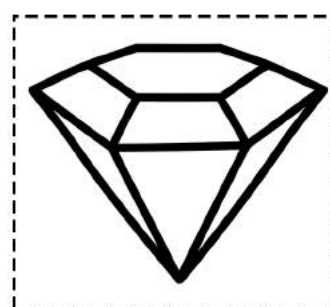
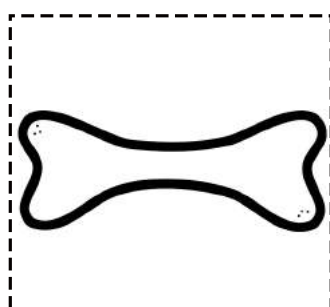
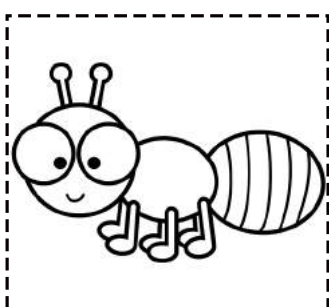
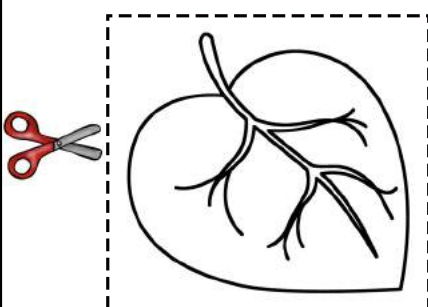

Todo sobre I i

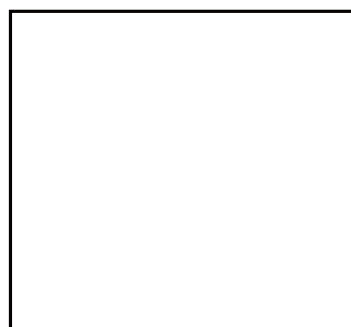
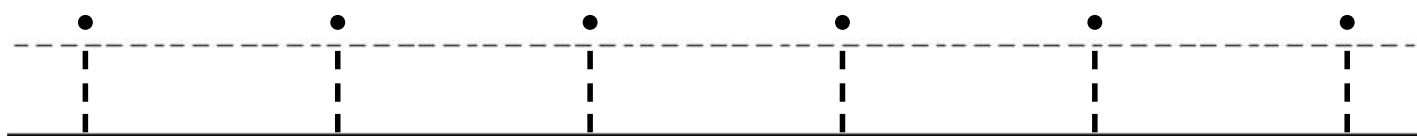
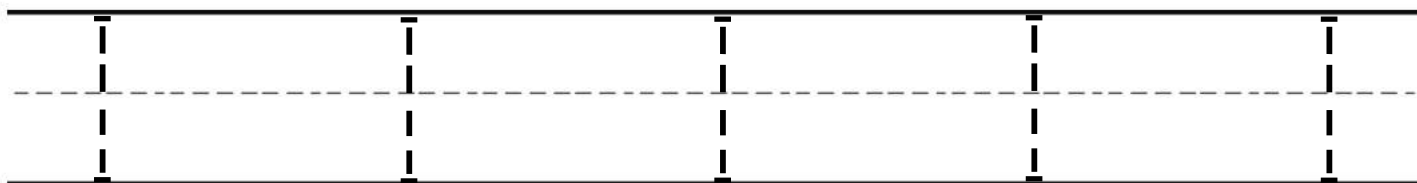
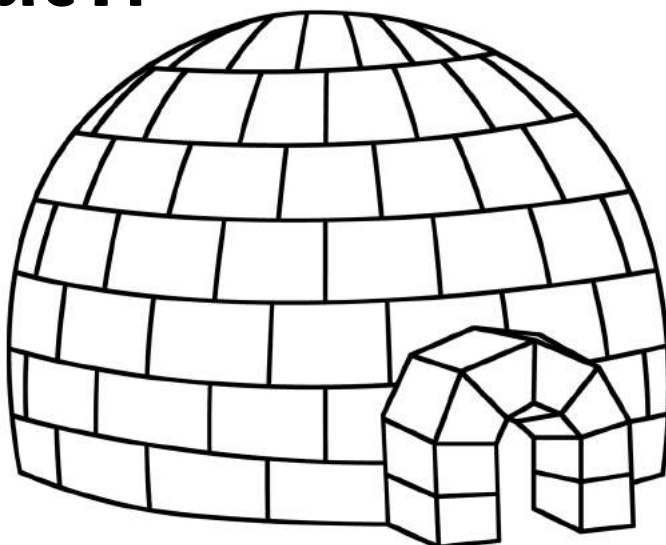
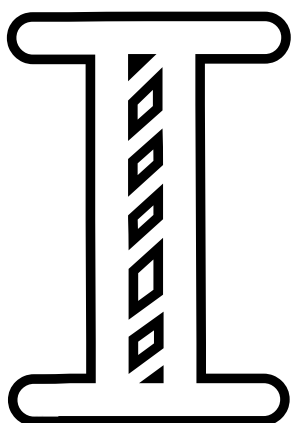

Recorta las imágenes. Pega las que comienzan con i

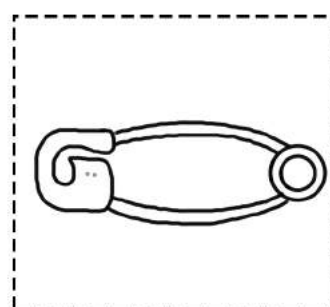
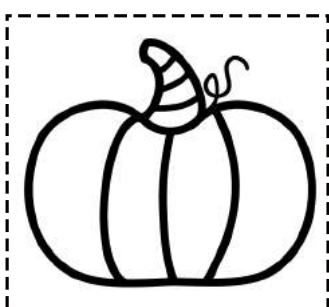
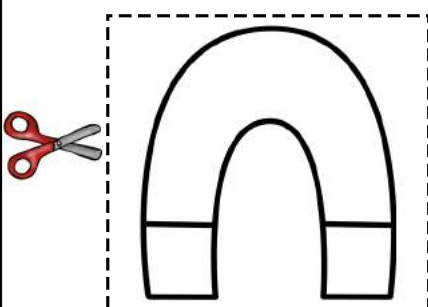

Todo sobre J j

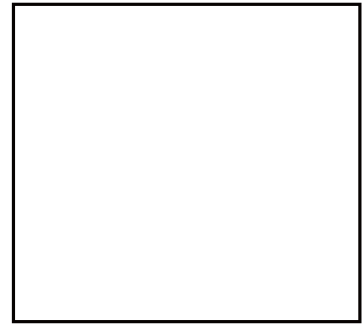
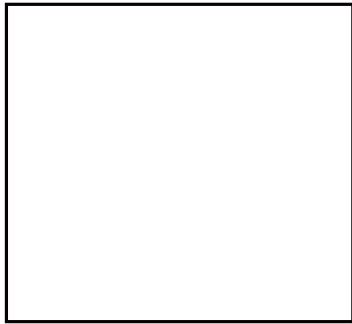
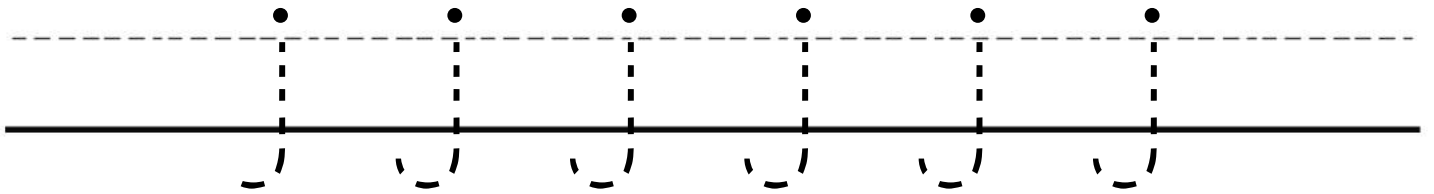
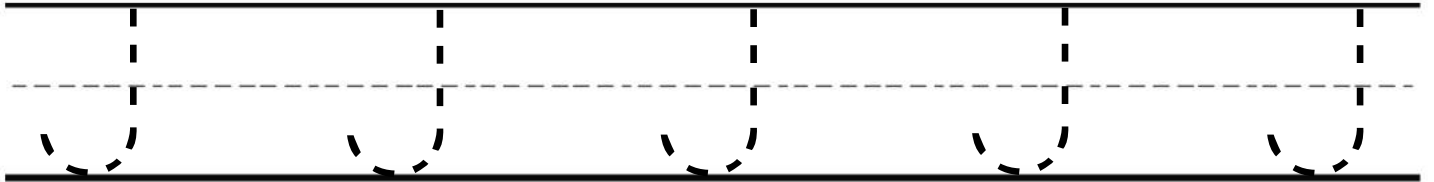
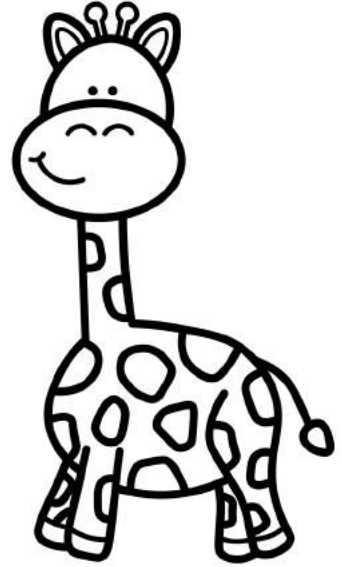
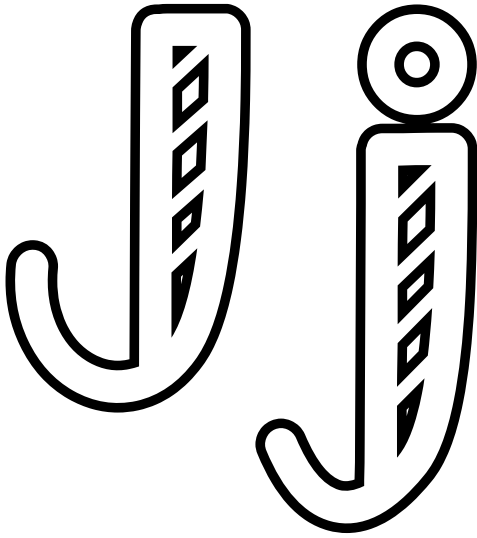

Recorta las imágenes. Pega las que comienzan con j

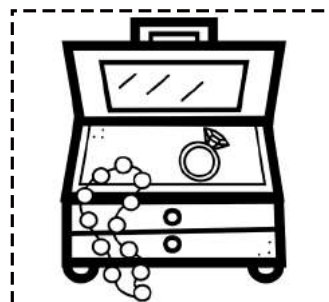
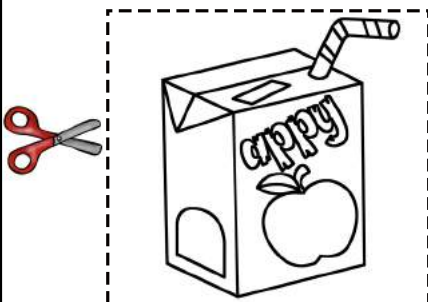

Todo sobre K k

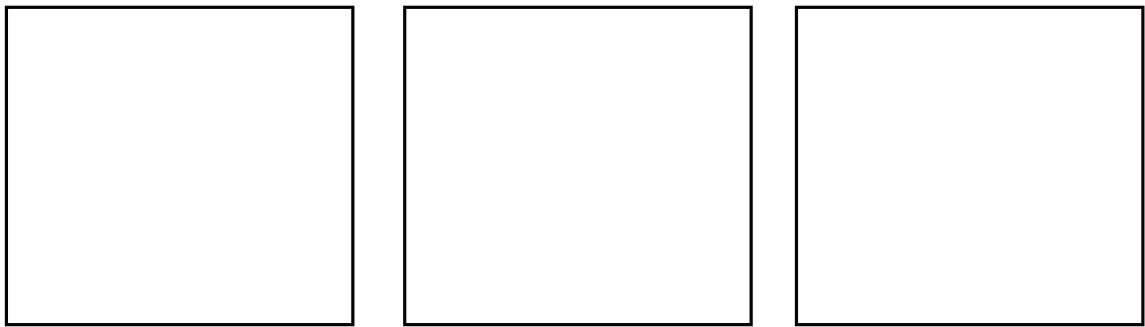
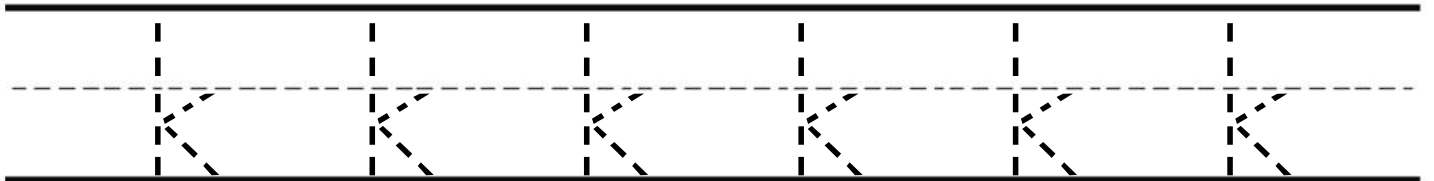
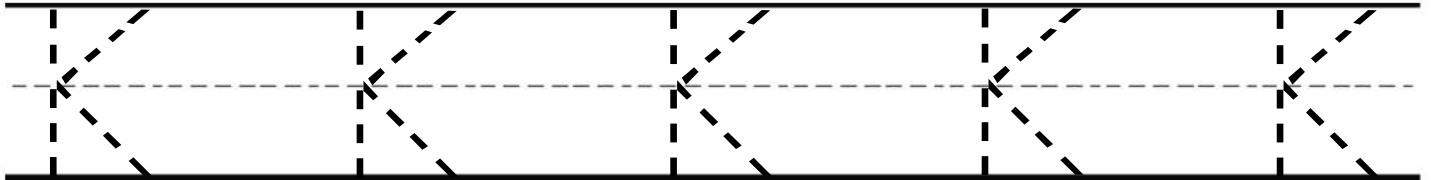
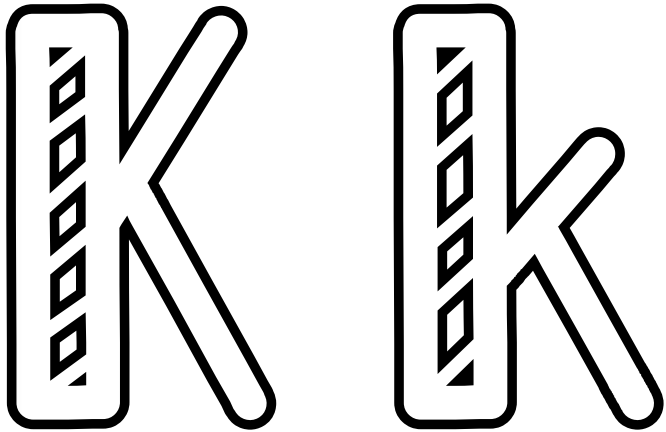

Recorta las imágenes. Pega las que comienzan con k

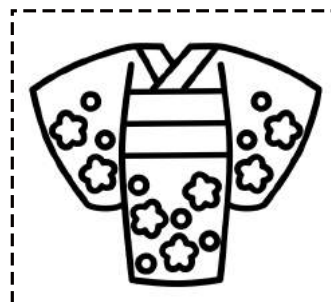
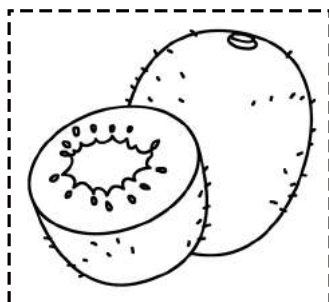
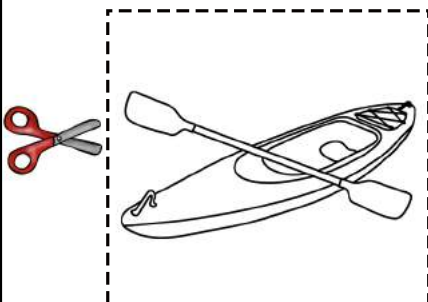

Todo sobre L I

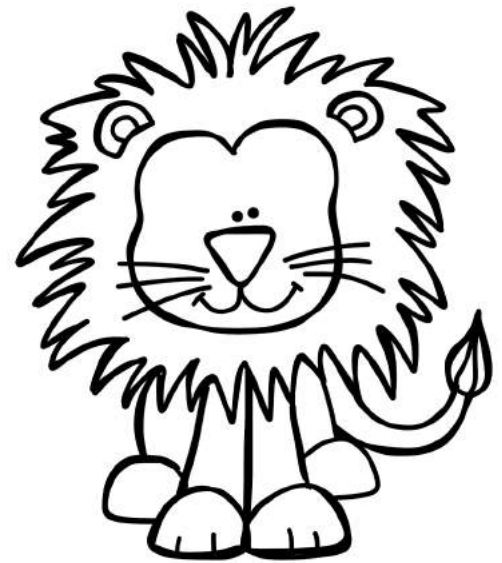
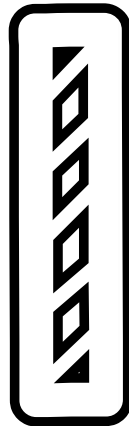
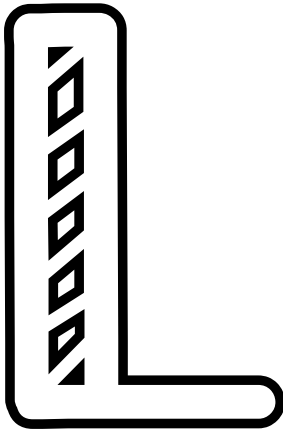

Two sets of handwriting practice lines, each consisting of a solid top line, a dashed middle line, and a solid bottom line, divided into six columns by vertical dashed lines.

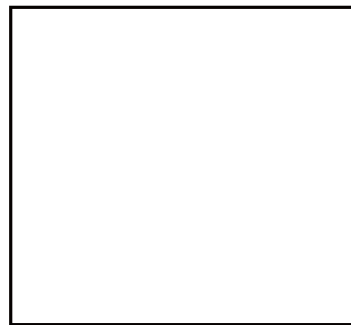
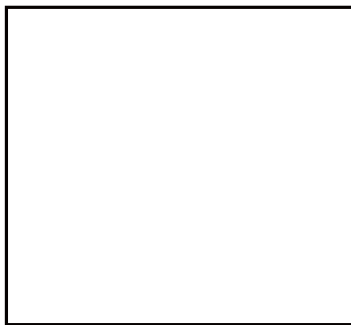

Recorta las imágenes. Pega las que comienzan con l

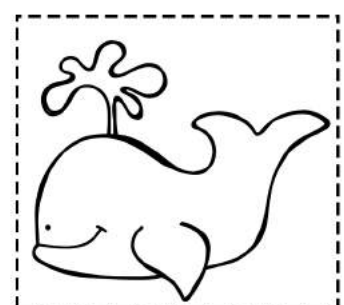
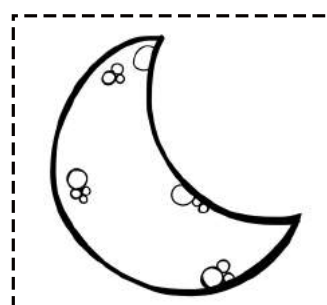
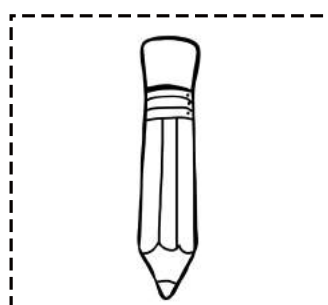
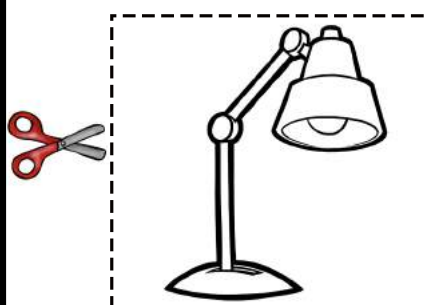

Todo sobre M m

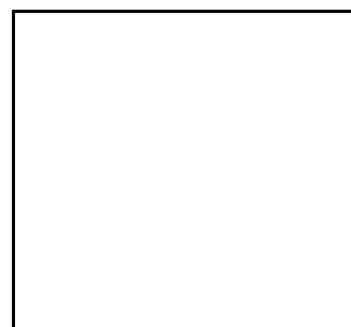
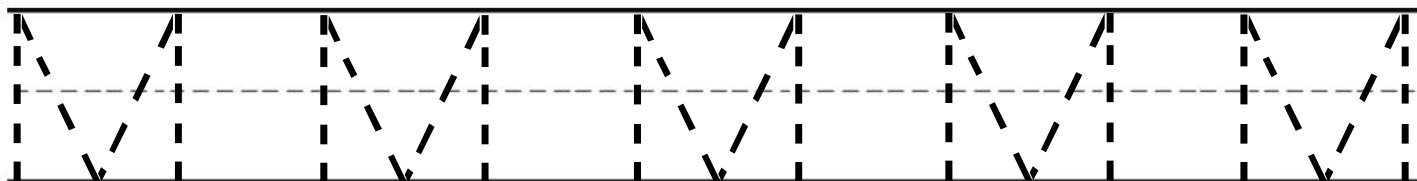
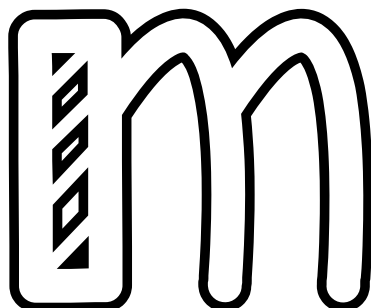
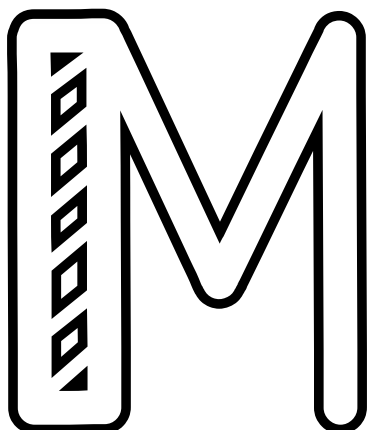

Recorta las imágenes. Pega las que comienzan con m

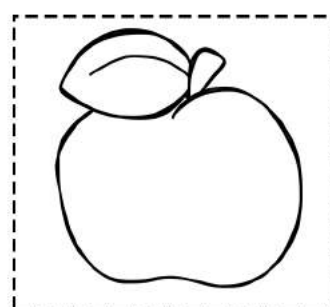
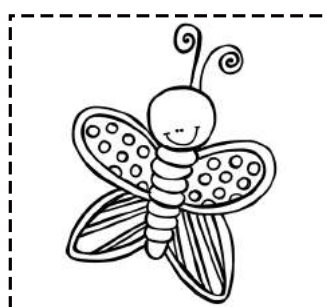
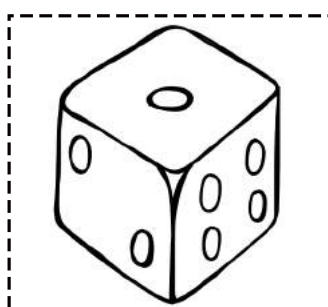
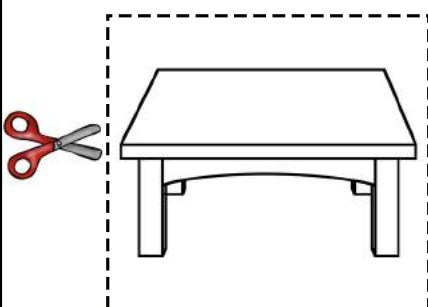

Todo sobre N n

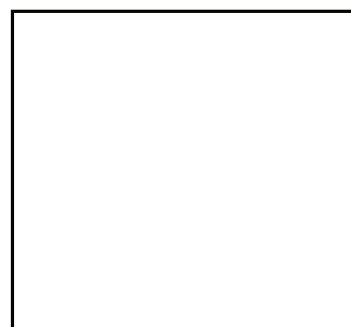
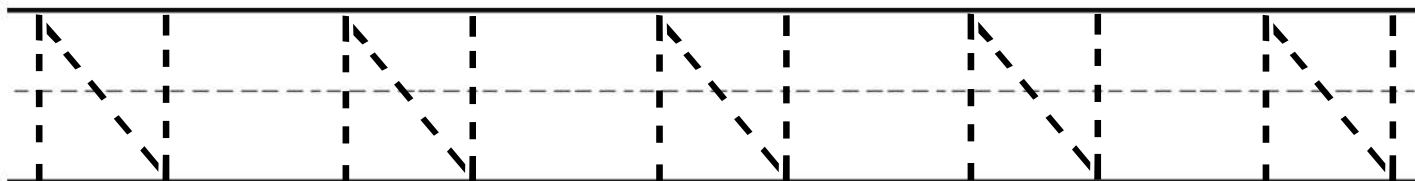
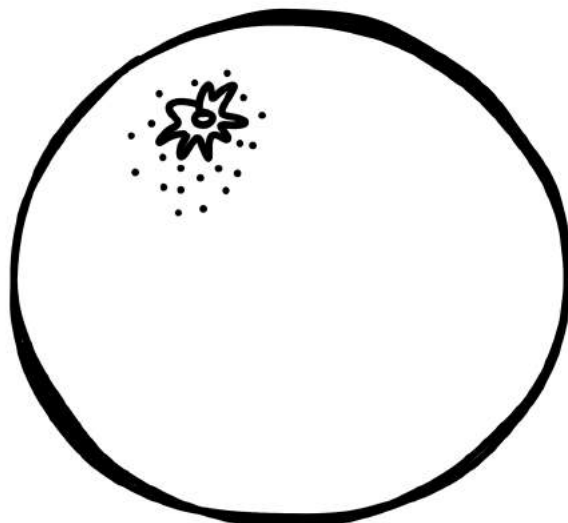
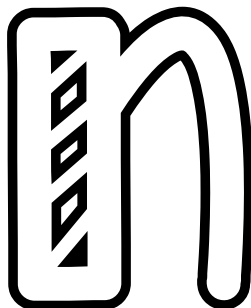
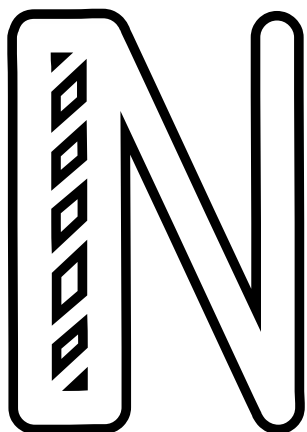

Recorta las imágenes. Pega las que comienzan con n

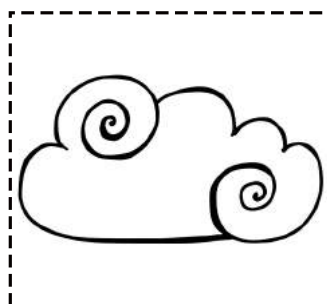
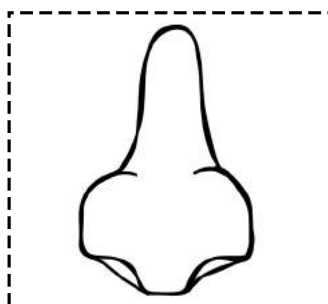
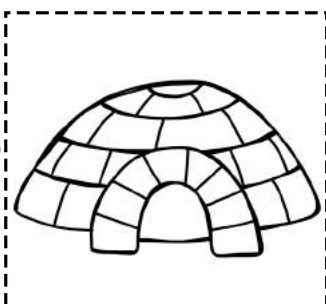

Todo sobre Ñ ñ

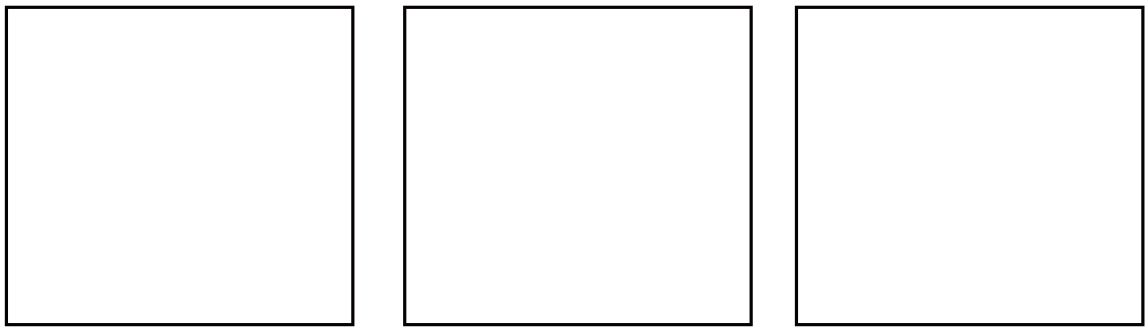
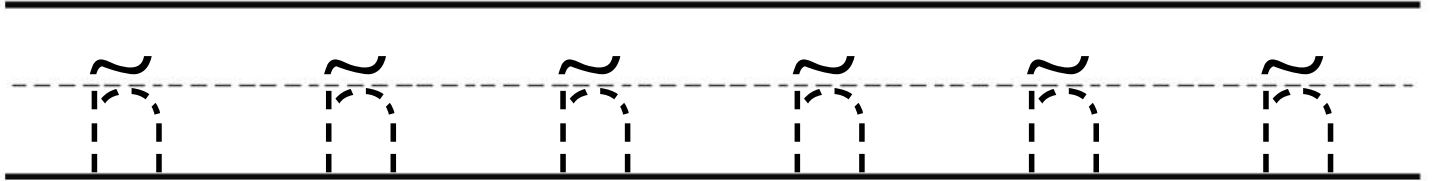
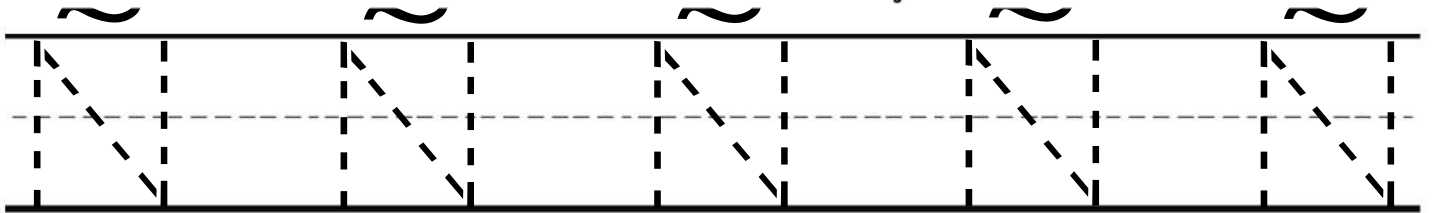
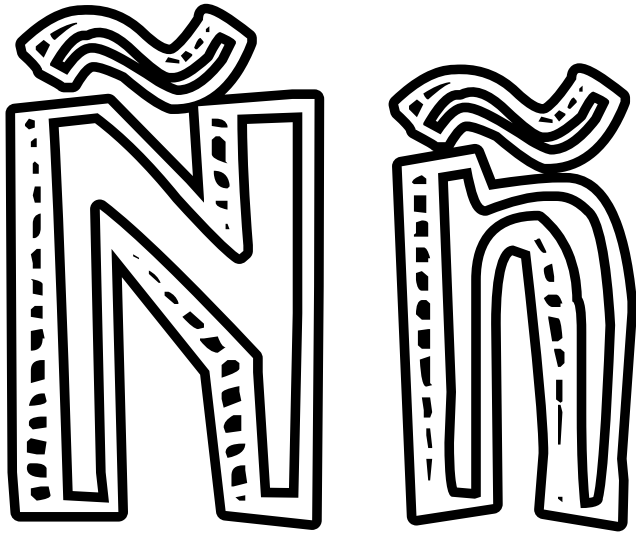

Recorta las imágenes. Pega las que comienzan con ñ

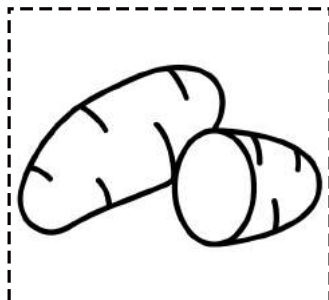
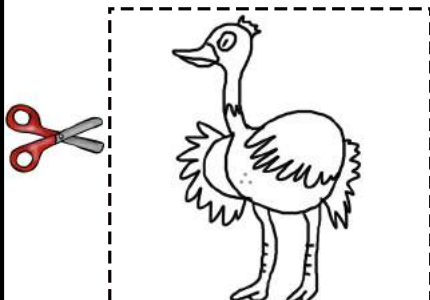

Todo sobre O o

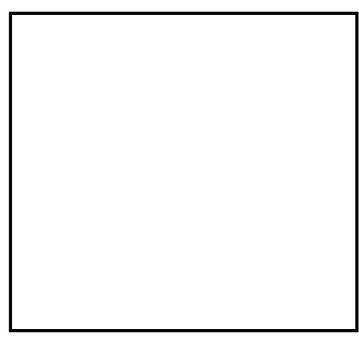
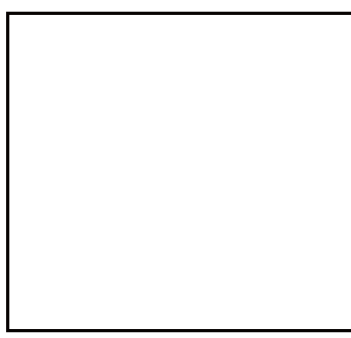
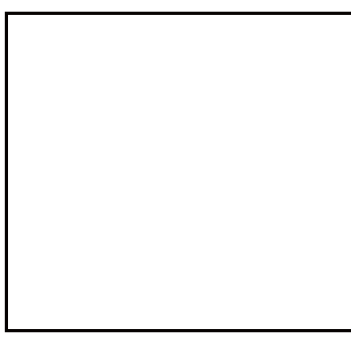
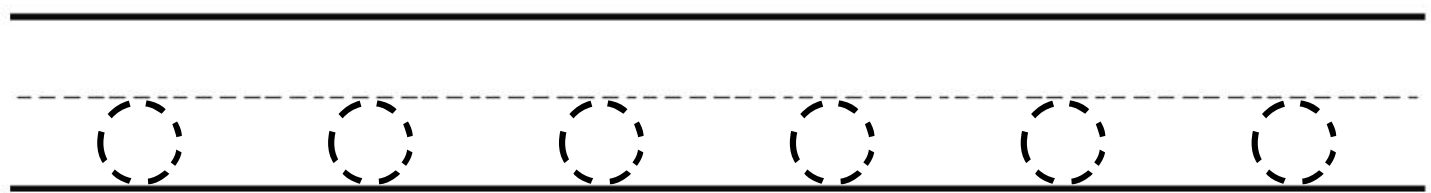
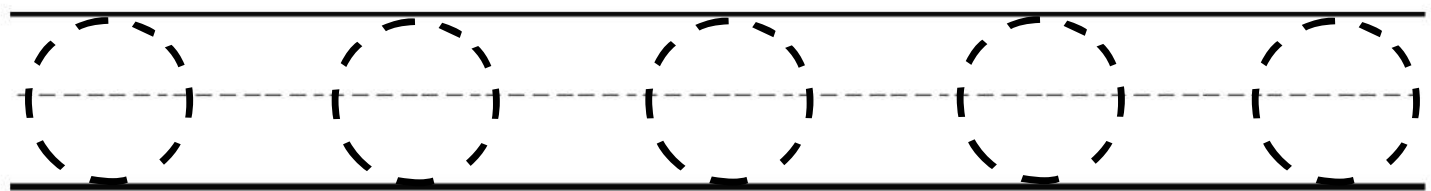
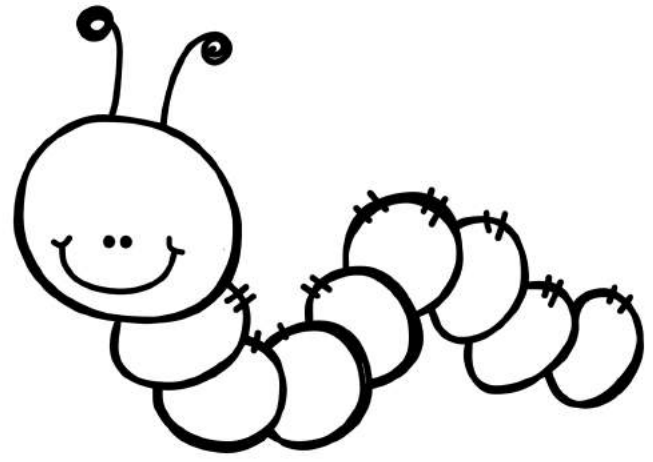
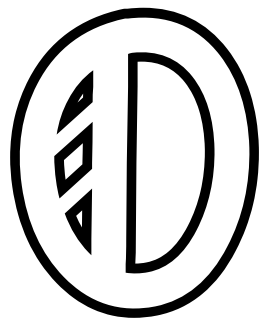
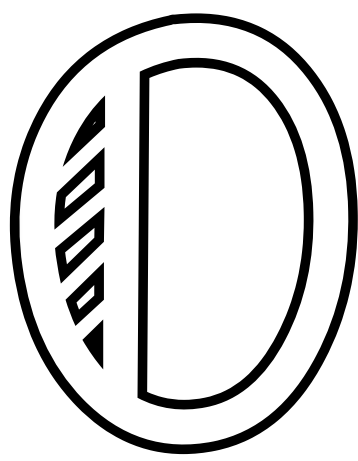

Recorta las imágenes. Pega las que comienzan con o

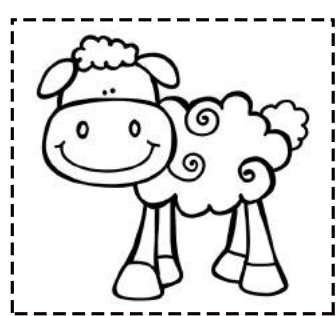
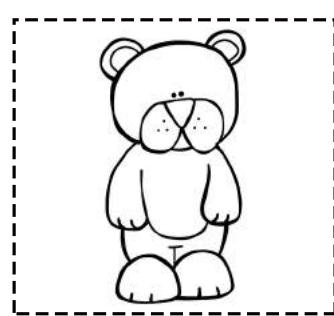
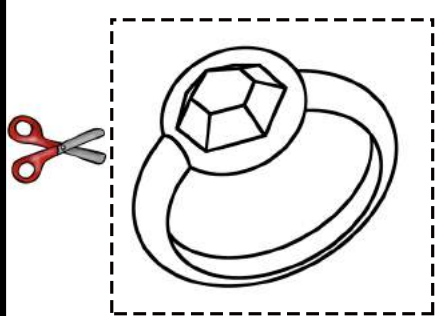

Todo sobre P p

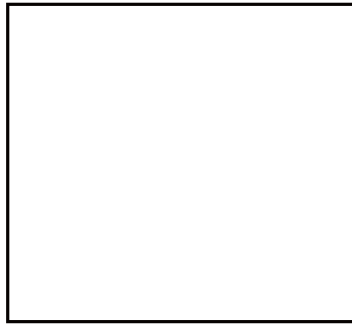
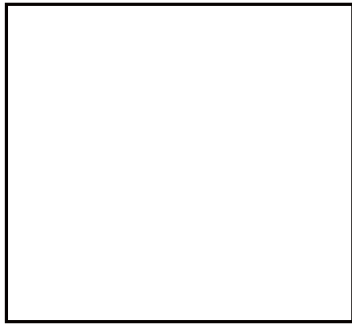
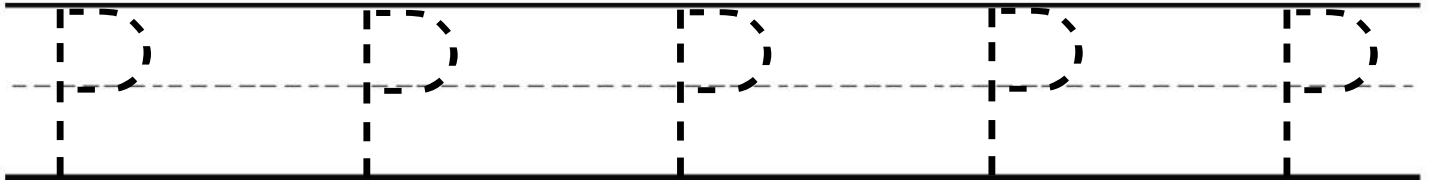
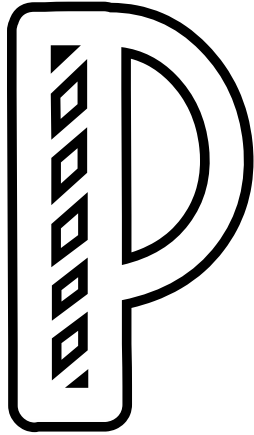
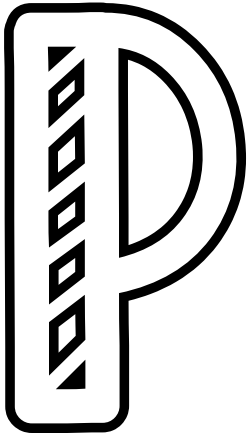

Recorta las imágenes. Pega las que comienzan con p

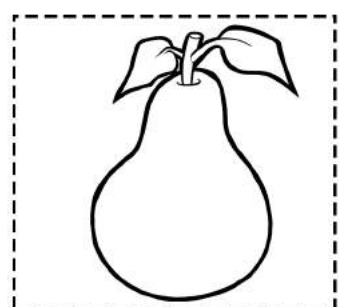
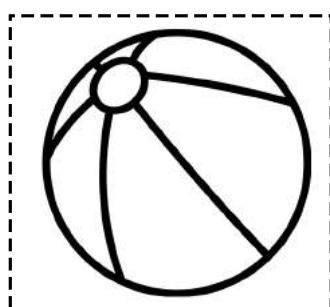
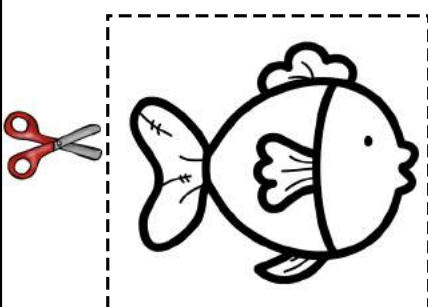

Todo sobre Q q

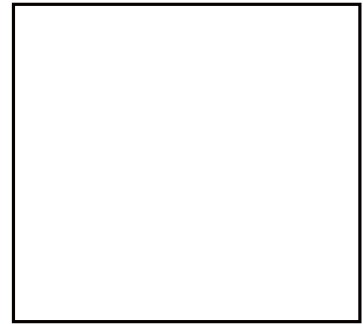
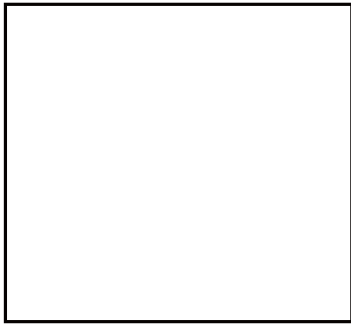
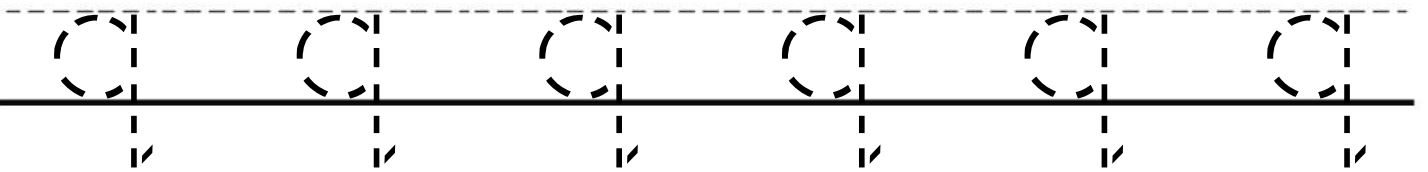
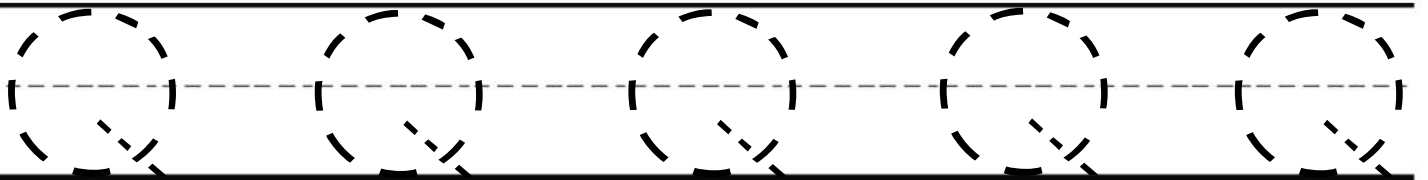
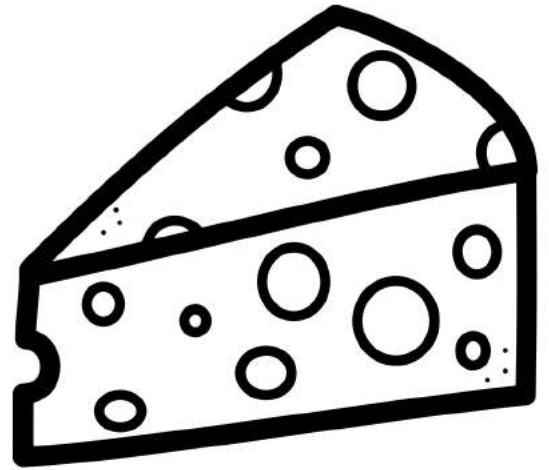
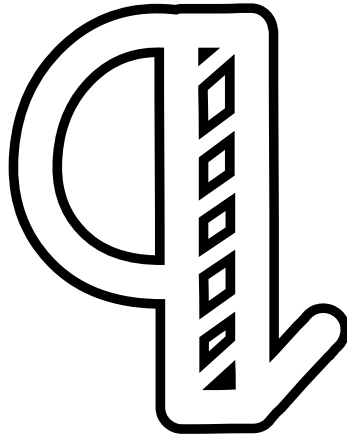
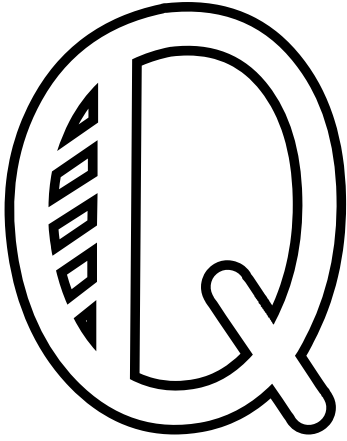

Recorta las imágenes. Pega las que comienzan con q

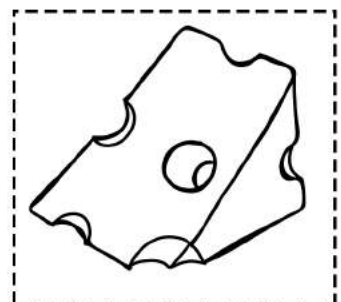
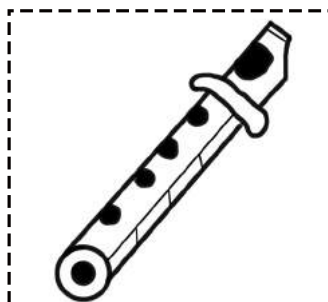
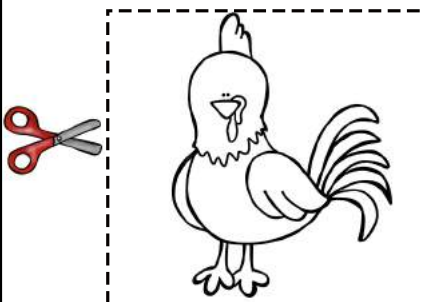

Todo sobre R r

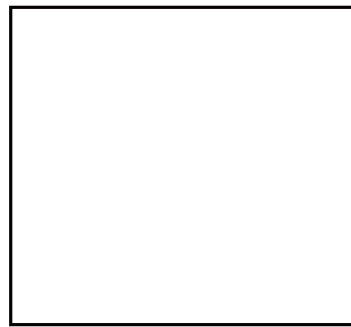
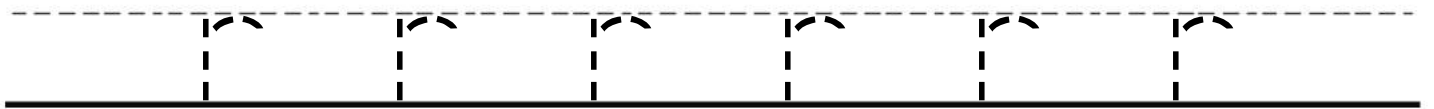
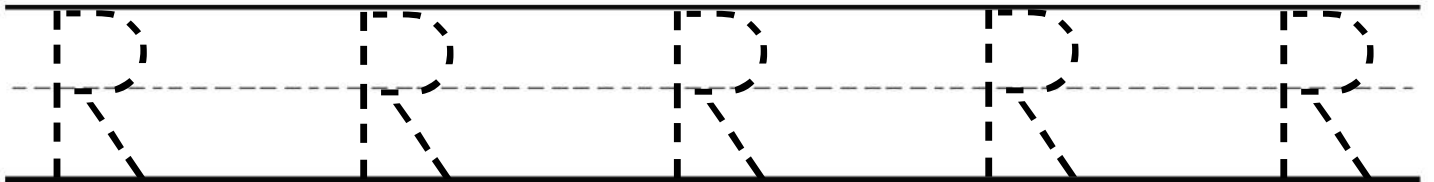
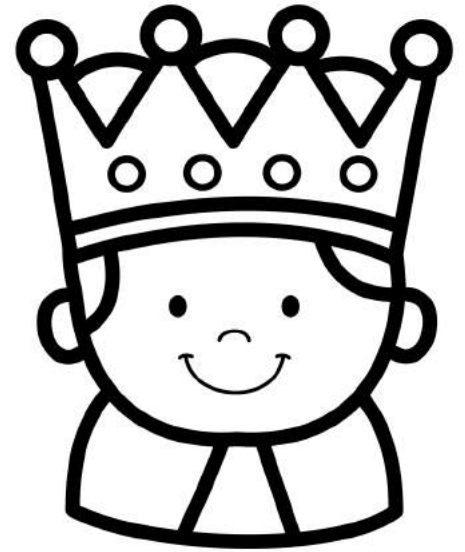
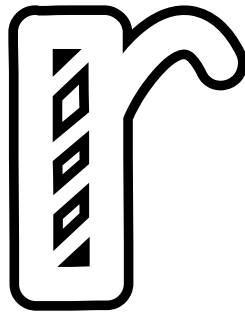
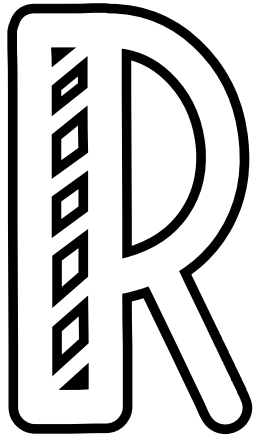

Recorta las imágenes. Pega las que comienzan con r

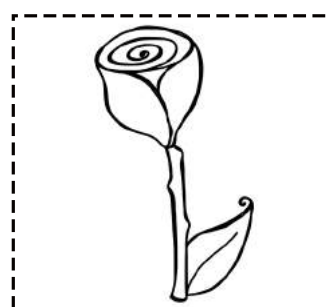
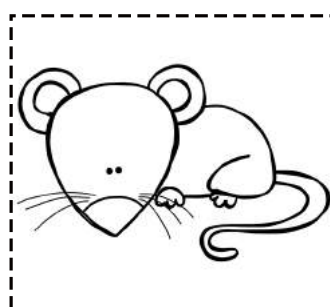
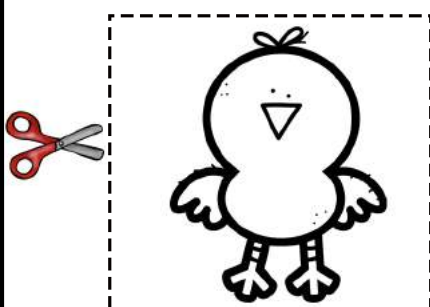

Todo sobre S s

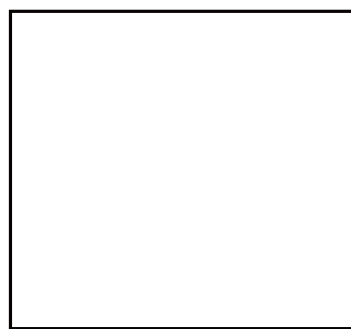
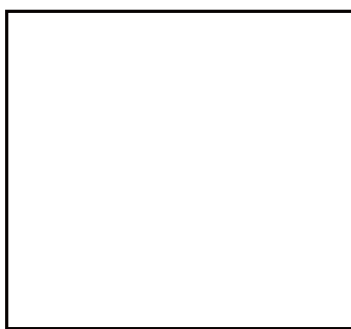
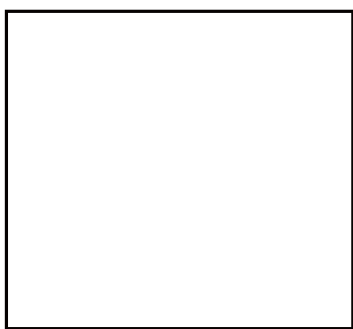
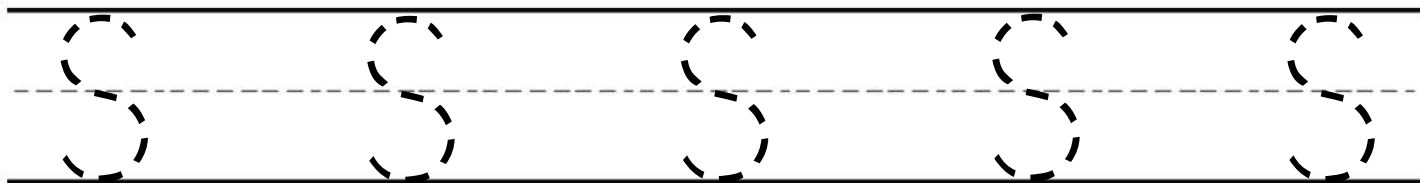
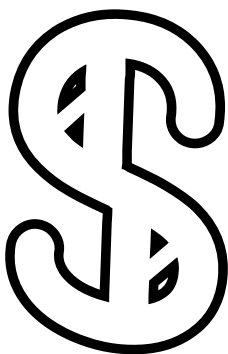
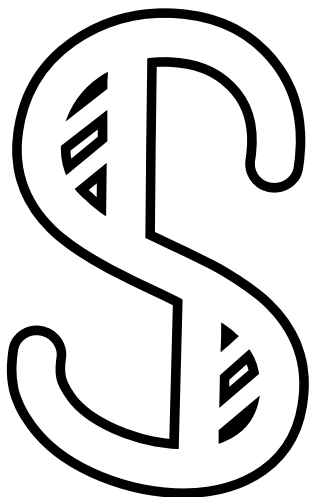

Recorta las imágenes. Pega las que comienzan con s

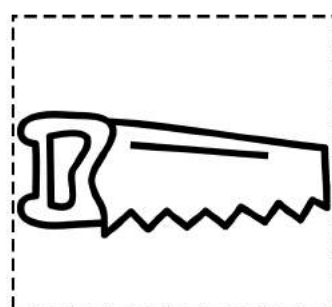
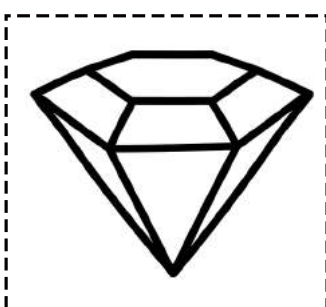
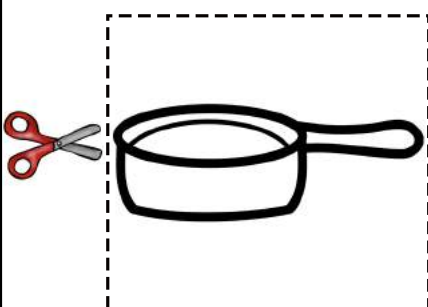

Todo sobre T t

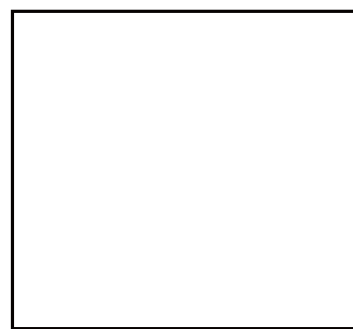
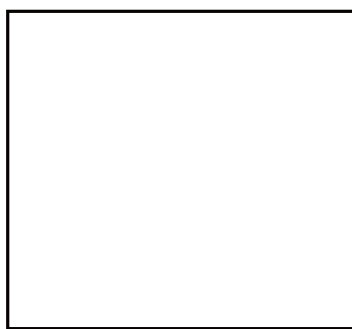
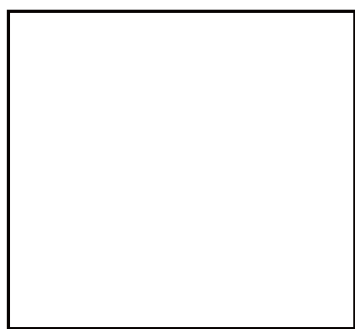
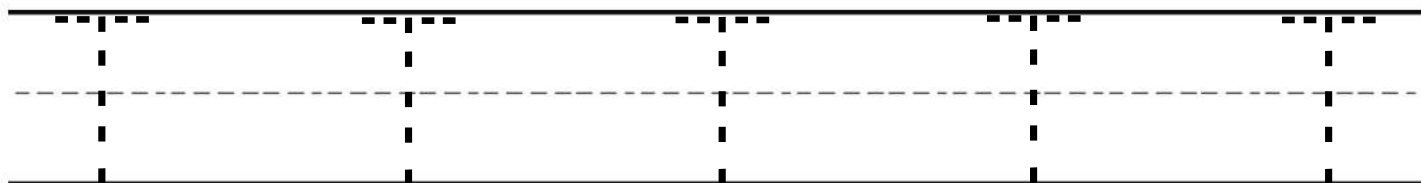
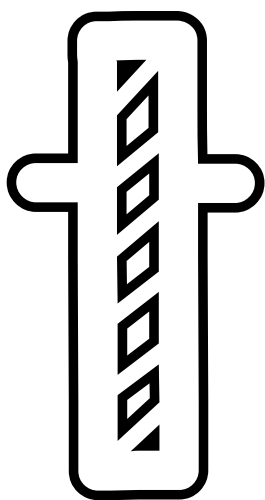
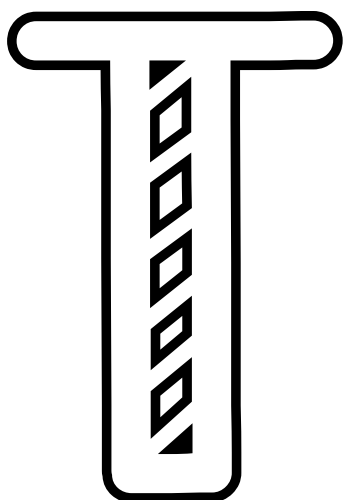

Recorta las imágenes. Pega las que comienzan con t

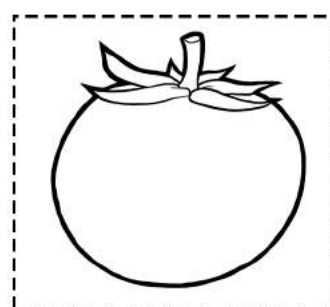
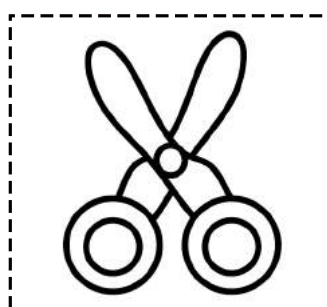
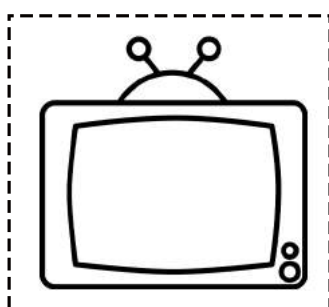
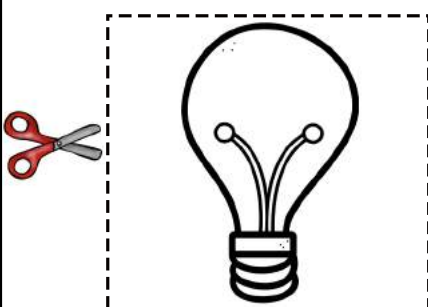

Todo sobre U u

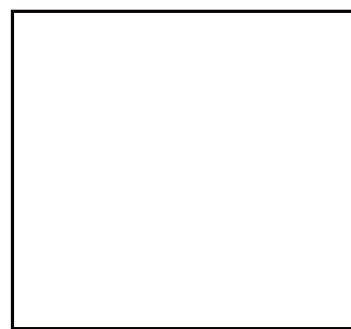
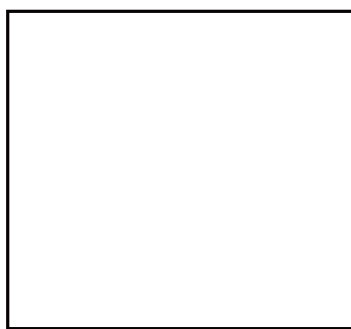
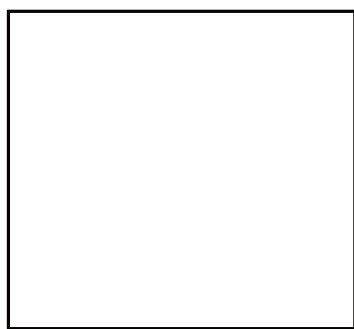
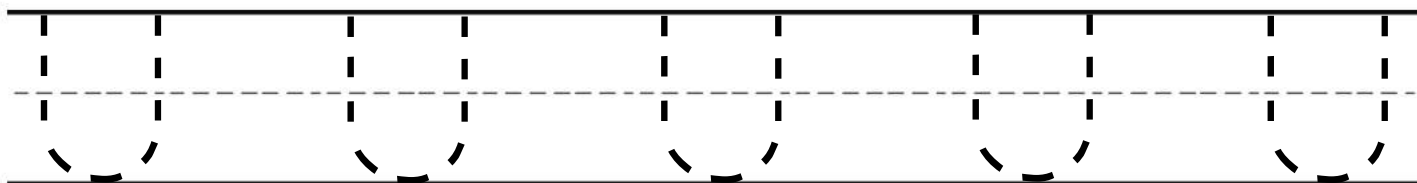
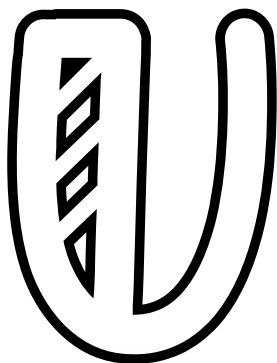
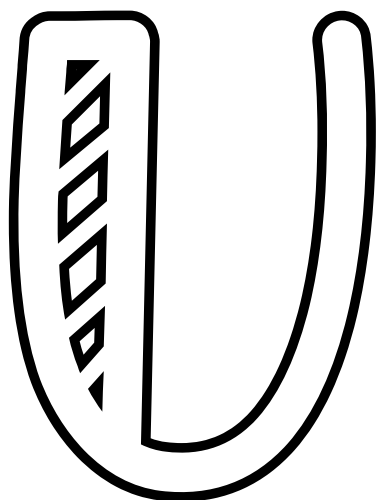

Recorta las imágenes. Pega las que comienzan con u

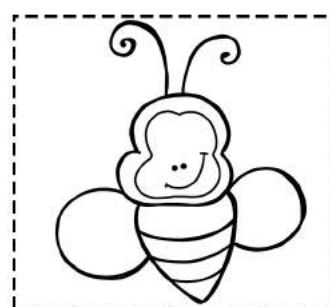
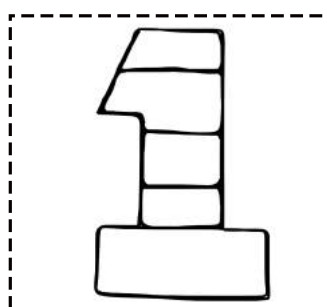
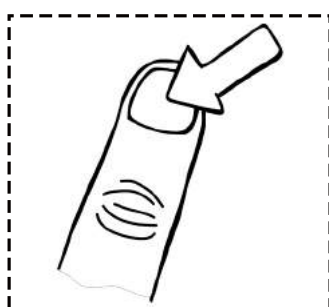
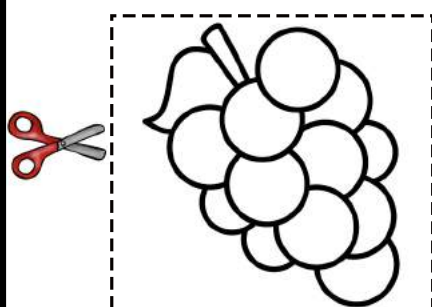

Todo sobre V v

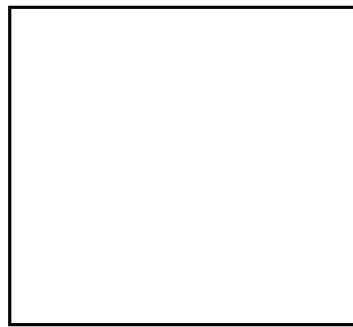
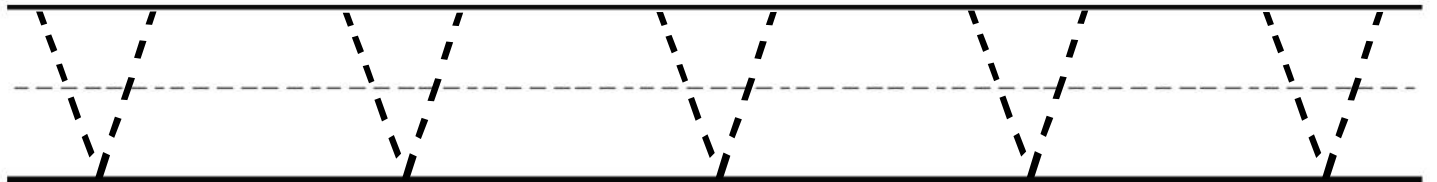
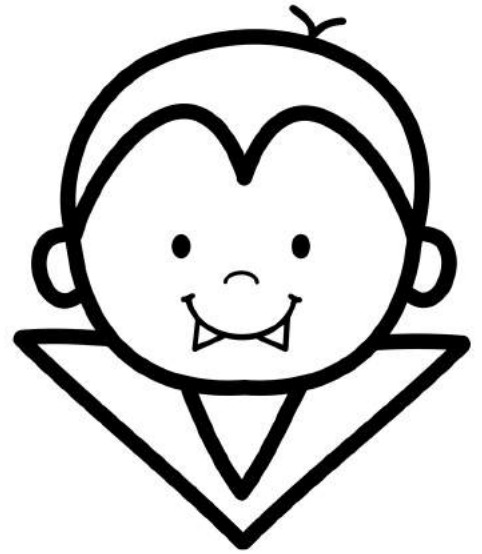
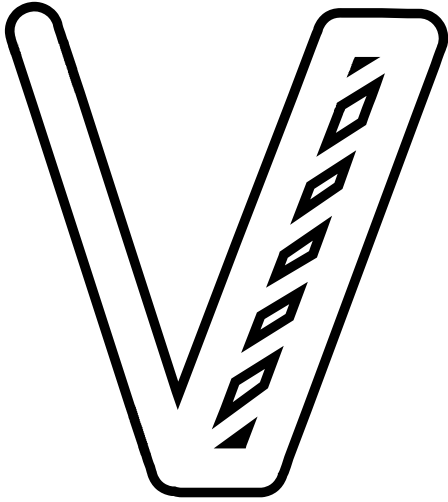

Recorta las imágenes. Pega las que comienzan con v

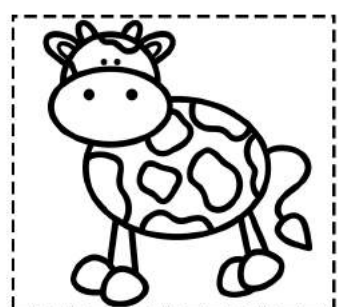
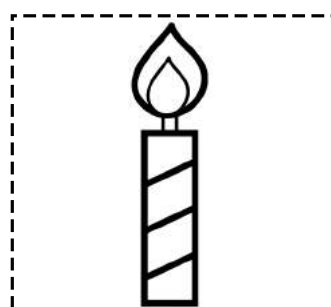
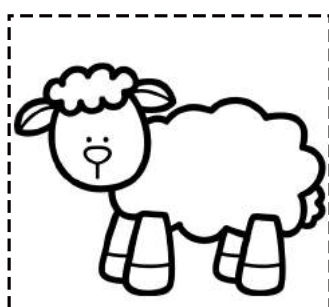
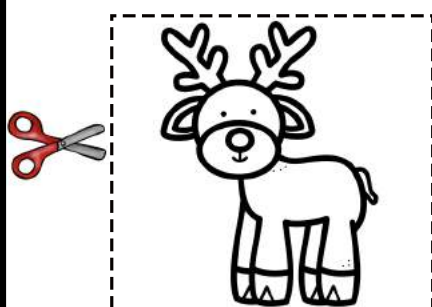

Todo sobre W w

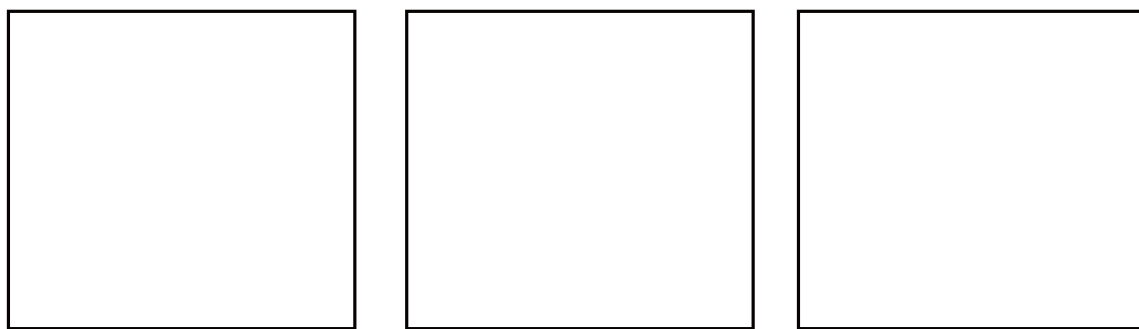
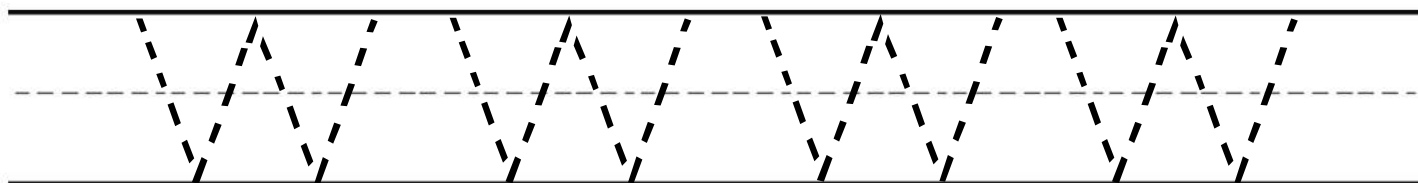
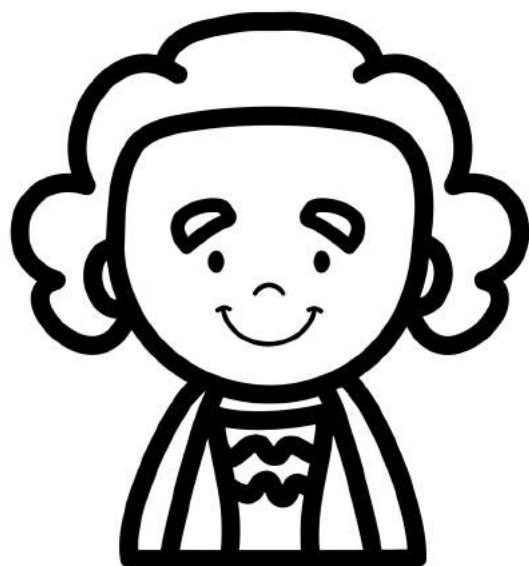
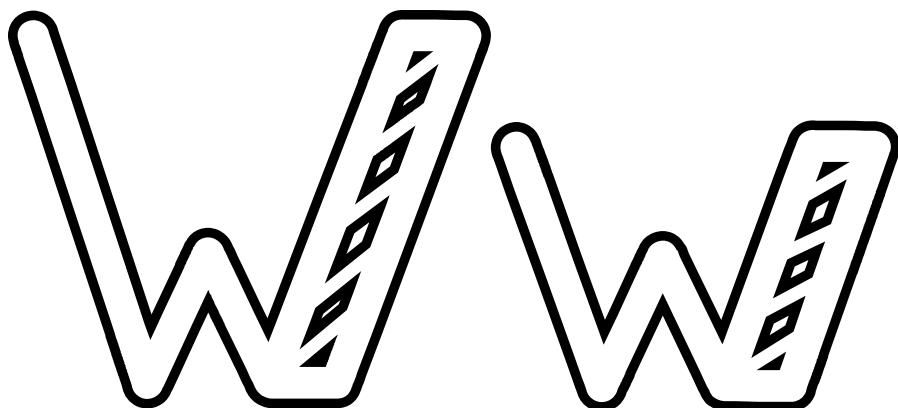

Recorta las imágenes. Pega las que comienzan con w

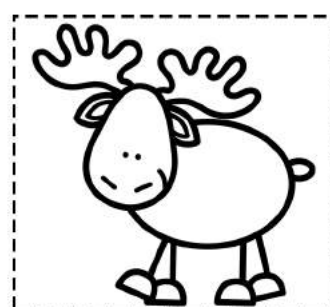
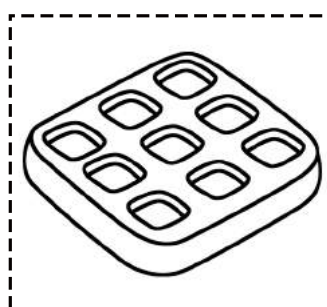
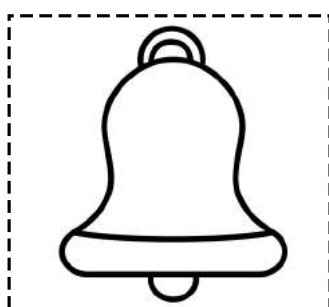
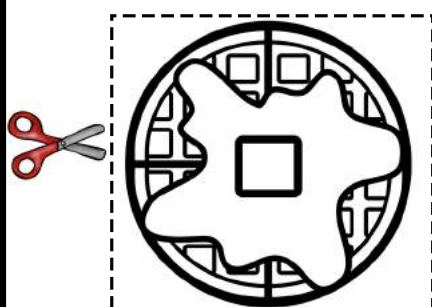

Todo sobre X x

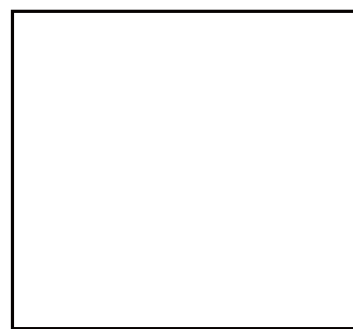
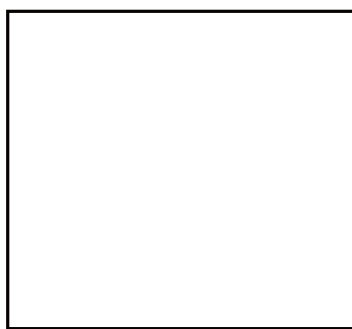
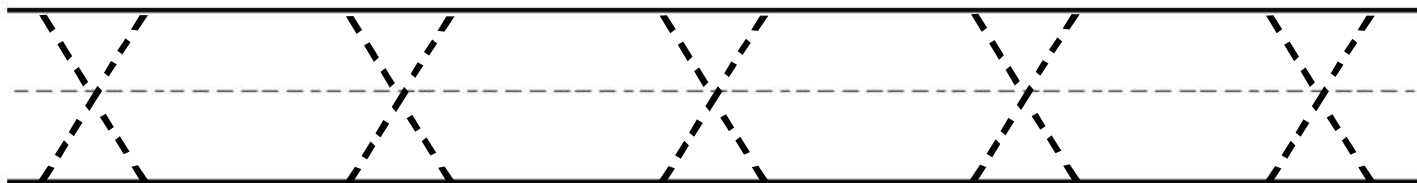
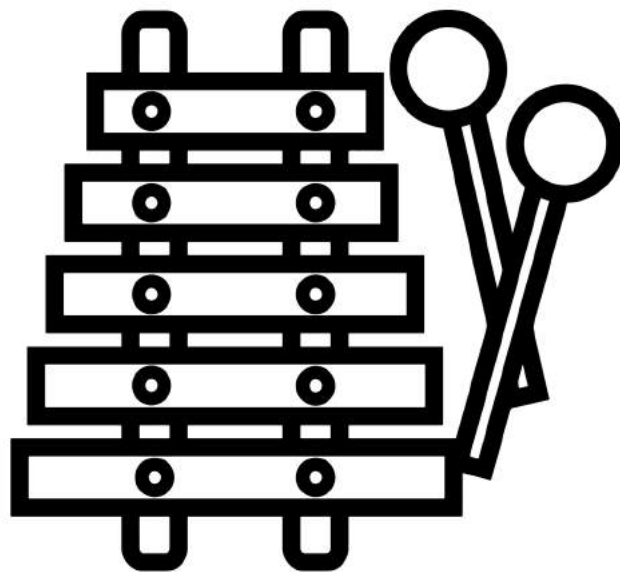
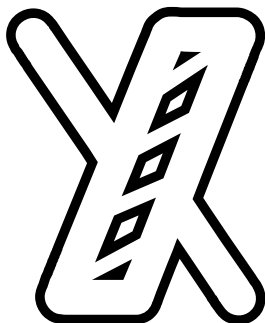
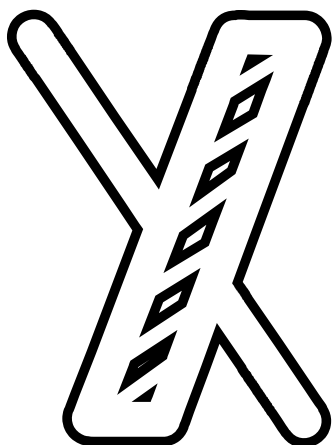

Recorta las imágenes. Pega las que comienzan con x

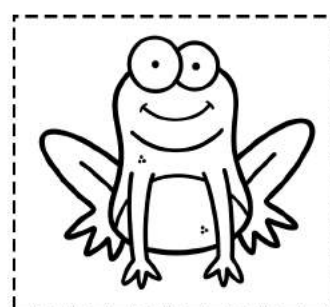
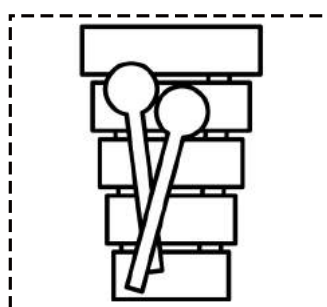
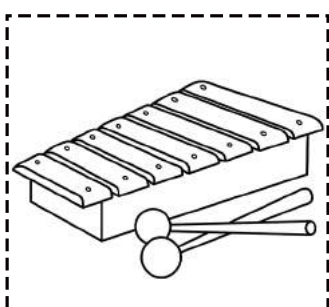
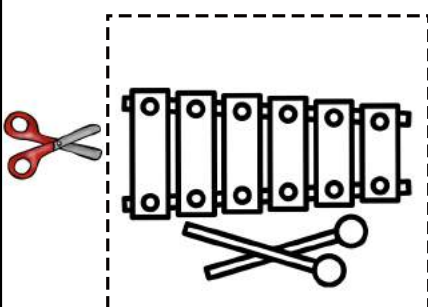

Todo sobre Y y

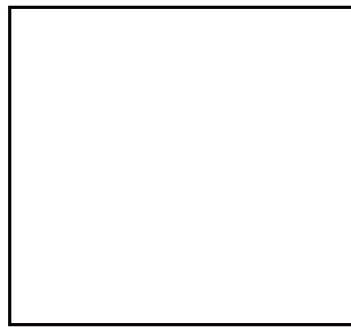
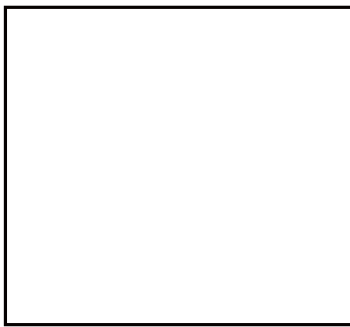
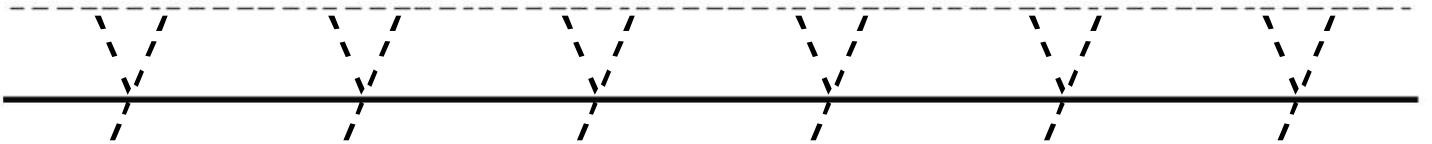
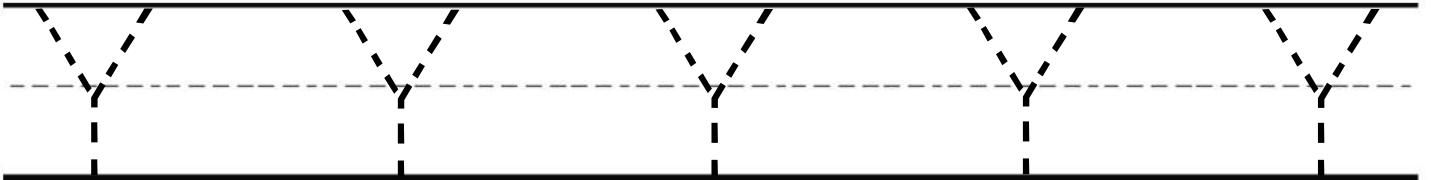
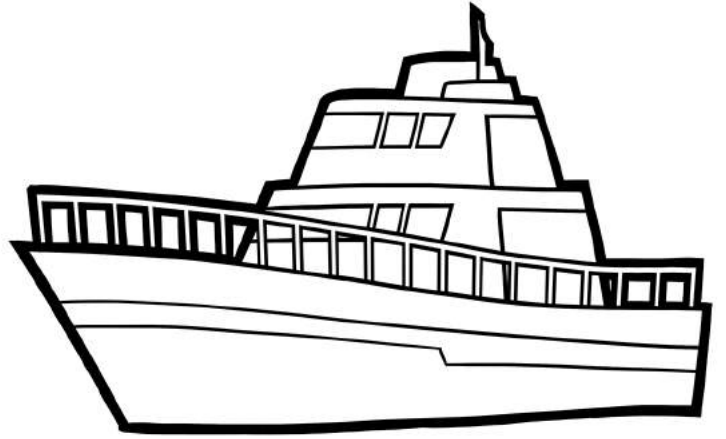
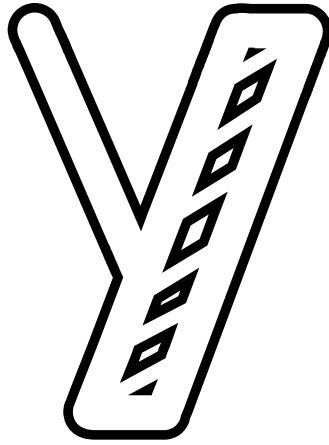
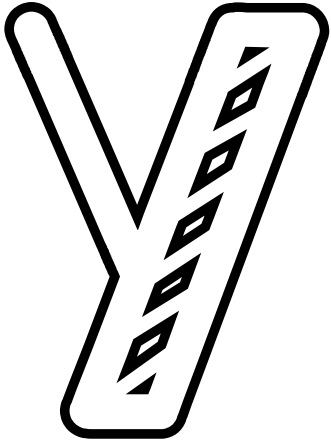

Recorta las imágenes. Pega las que comienzan con y

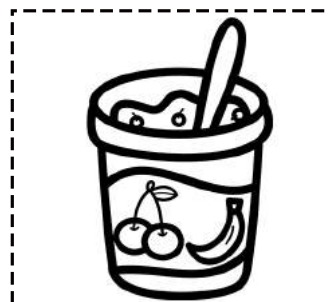
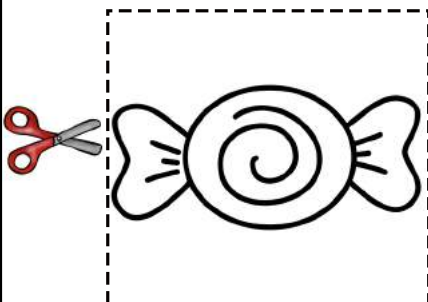

Todo sobre Z z

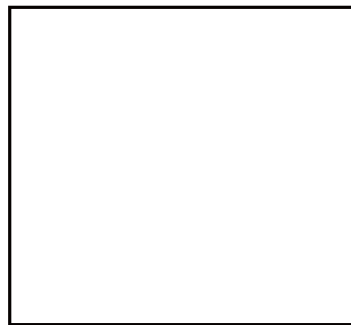
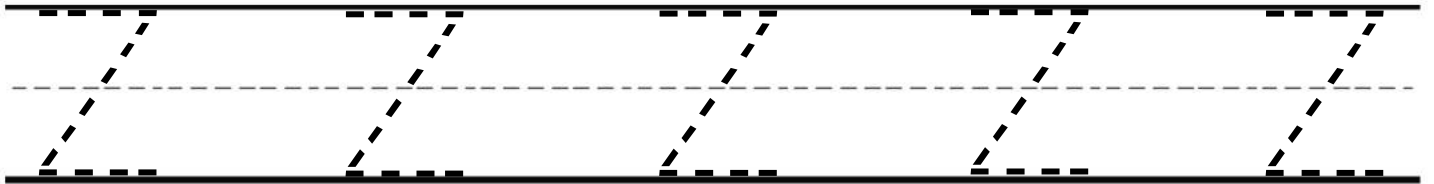
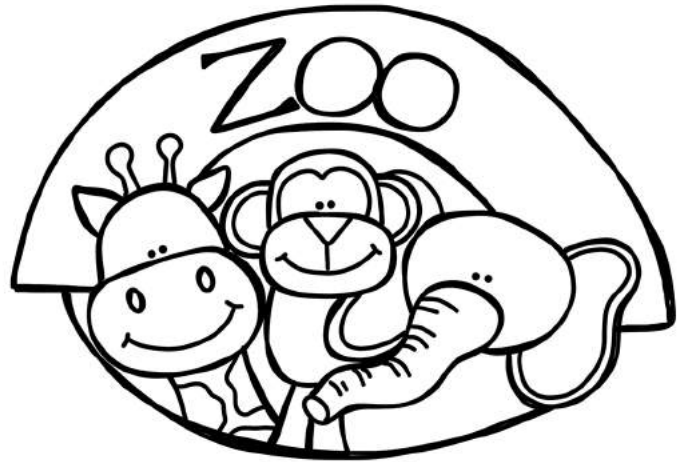
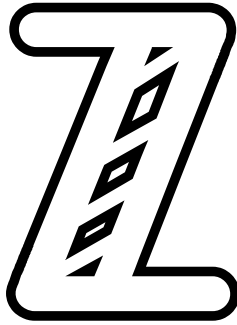
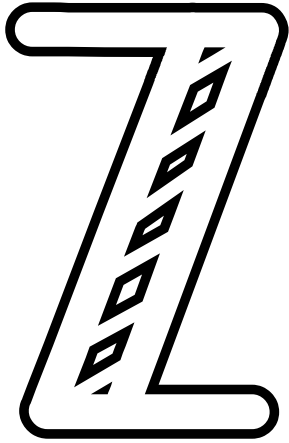

Recorta las imágenes. Pega las que comienzan con z

